

BARNCRAFT®

Sliding Doors & Hardware



NEW!

- Houdini Hardware™ — hidden from view!
- Door heights up to 9-foot tall!

GLASS★CRAFT®
DOOR COMPANY

WHY BARNCRAFT®?

BarnCraft sliding doors are made by GlassCraft Door Company, an award-winning residential door manufacturer based in Houston, TX. GlassCraft brings its manufacturing and service excellence into producing this premium selection of sliding doors made of Mahogany, Knotty Alder, Knotty Pine, MDF, Metal and Birch. Offering premium products with numerous options at an affordable price, BarnCraft is a unique brand in the market. A harmony of design, craftsmanship, durability and affordability, BarnCraft provides an excellent choice for that perfect sliding door.

ABOUT GLASSCRAFT®

GlassCraft Door Company, founded in 1977, is an award-winning manufacturer of premium wood, fiberglass composite and rolling barn doors. From its 225,000 square foot manufacturing facility in Houston, Texas, GlassCraft's team of dedicated artisans, designers and master craftsmen create a distinctive selection of the most beautiful doors and entryways available. This dedication to excellence is built into each product and continues with industry leading customer service and product warranties.

Cover: 48" wide x 107" tall MDF 1 Panel Plank design (see page 36), in Grey Clouds Palette color paint finish, with NEW Houdini Hardware and stainless steel Metro 60" pull handle.

This photo: 60" wide x 96" tall Double X Barnwood Knotty Alder door (see page 29) with Driftwood finish, Waggoner sliding hardware, and Gila 24" pull handle.

Opposite page: 42" wide x 84" tall Contemporary Metal 12 Lite double doors (see page 43), with Black Gage hardware.



4 STEPS TO CREATING THE PERFECT SLIDING DOOR



1. Select your door configuration.

Single or double door? Bypass Double or Quadruple? Refer to the configuration information on pages 4-5 to help select your sliding door installation type.

2. Select your door.

The BarnCraft® Collection offers eight different sliding door series in this catalog featuring various door designs, glass and finish options. This includes Knotty Pine Barn Doors, Knotty Alder Barn Doors, Iron Plank, Carved MDF, Contemporary Metal & Glass, Contemporary Birch, Mahogany & Glass Doors, and the Rustic Farmhouse Series. Visit www.glasscraft.com to view other GlassCraft doors that may be used for sliding door applications.

3. Select your sliding door hardware.

Choose from eight heavy-duty metal sliding traditional hardware options with black or stainless steel finish options (select designs). Or select our new Houdini Hardware™ concealed hardware option. BarnCraft® traditional hardware includes nylon wheels and Houdini Hardware™ has urethane wheels – both for a quiet-glide operation (pages 6-10).

4. Select your options.

Consider adding these functional and decorative options to your BarnCraft® sliding doors:

- Soft-Close option for smoother and safer open/close operation (see page 12 – standard on Houdini Hardware).
- Pulls and Handles in black and stainless steel finish (see pages 16-17).
- Header boards for added structural support (see page 13).
- Privacy Locks (see page 15).

All photos, drawings, and product designs in this catalog are copyright ©2023 GlassCraft Door Company, Houston, Texas. BarnCraft, GlassCraft, GlassCraft Door, GlassCraft.net, Houdini Hardware, and the GlassCraft logo are all trademarks. Any duplication without specific written authorization from GlassCraft Door Company is strictly prohibited. All rights reserved. GlassCraft Door Company reserves the right to change product designs and product specifications at any time for any reason and without notice. Standard lead-times may change without notice and should only be used as a guideline for placing orders. The images throughout this catalog, showing the prefinish color options offer an indication of the final appearance, but due to variations in the texture, grain and color of the wood, the actual appearance will vary.

For information on product warranty please visit our website at www.glasscraft.com

SINGLE & DOUBLE DOOR CONFIGURATIONS



Single Door Installation

The single door installation may be used when there is sufficient wall space to the right OR the left of the wall opening that is at least 6" wider than the actual wall opening. For instance, if your wall opening is 36" wide, then you should have at least 42" of available wall space to the right or to the left of the wall opening.

Consider an extra-wide single door if you have a wider sized opening that has sufficient wall space. If wall space is available on BOTH sides of the opening, you might want to consider a double door installation. Alternatively, if there is little or no wall space on EITHER side of the wall opening, then you might consider the double BYPASS door installation.

Both traditional and Houdini hardware options are available for single door installations.

Double Door Installation

The double door installation may be used when this double door gives the desired appearance and when there is sufficient open wall space on both sides of the door opening. We suggest that this available wall space should be at least 2" wider than half the width of the opening. For example, if your opening in the wall is 60" wide, then half of this measurement is 30". And you should have at least 32" (30" + 2" allowance) of wall space both to the right side and to the left side of the opening.

For a double door installation, you will need 2 doors and 2 sliding door hardware kits. The rails from each of the 2 kits meet in the center above your wall opening. The Double Door Rail Connector (see page 10) is an available option that mounts across the joined ends of the 2 door rails for a seamless double door configuration.

Both traditional and Houdini hardware options are available for double door installations



Photography courtesy of @grandlivinghomescarolinas
Photographer: @metropolisiconicshots

BYPASS DOUBLE /QUAD CONFIGURATIONS & OPTIONS



Bypass Double or Quadruple Door Installation

The Bypass door installation may be used when this is the desired appearance and when there is INSUFFICIENT wall space to the right AND/OR the left of the wall opening for a traditional barn door installation. A double bypass installation uses two sliding door tracks instead of one. The second door track is cantilevered in front of the first track. The doors roll in front and behind each other.

For a Bypass Double door installation, you will need 2 doors, 2 sliding door hardware kits plus 1 bypass rail bracket kit (see pg 14). For a Bypass Quadruple door installation (such as shown at left – see door on pg 49), you will need 4 doors, 4 sliding door hardware kits, plus 2 bypass rail bracket kits. Visit www.glasscraft.com/video-resources/ to view installation videos.

Available only with Traditional hardware options.

Traditional Hardware or Houdini Hardware™?

Traditional hardware is the term used for standard “barn door” installation hardware. The door hangs from a metal rail mounted on the wall and 100% of the weight of the door is supported from this rail. The rail and door rollers are visible, and are available in a variety of roller designs and in 2 finishes — black and stainless steel.

Houdini hardware is completely hidden from view. No wall-mounted rail is necessary. The weight of the door is 100% on the floor, as wheels are mounted on the bottom of the door. A support track is mounted on the upper backside face of the door, and this track follows a wall mounted support that keeps the door upright and attached to the wall.

The door offerings in this catalog each note if Traditional or Houdini hardware may be used.



Concealed Houdini Hardware on an 8'0" tall MDF 1 Panel Plank door (see page 38) with Softened Green paint finish.



Traditional barn door hardware or concealed

Traditional barn door hardware is shown throughout this catalog (see page 10) and features visible door rails mounted to the wall. The barn door used with this traditional hardware hangs from visible door rollers which roll on the door rail. All of the weight of the barn door is supported by these rollers and the wall-mounted door rail.

The patent pending Houdini Hardware™ features concealed rails and rollers — this hardware is not visible on the wall, as it is mounted at the bottom edge and the back top edge of the door. Wheels mounted at the bottom of the rolling/sliding door roll directly on the floor, and carry 100% of the weight of the door. Since the door rolls on the floor, this system is not compatible with most carpet — only a very tightly weaved carpet may be compatible. The hardware is easily mounted on the wall, and is not visible even when the door is fully open or fully closed. An aluminum door track is mounted on the back of the door at the top edge. This Houdini Hardware requires doors that are 1-3/8" to 1-3/4" in thickness, and no more than 48" wide, with a weight of less than 175 pounds. Order two Houdini Hardware kits for a double-door installation.

The Wall Mount is fixed to the wall at the top of the rolling door with 6 fasteners. Two rollers guide the door and keep it attached to the wall. The Wall Mount is 5.9" wide and features a vertical adjustment knob and two safety anti-jump guides to keep the door secured to the wall. The Houdini Hardware also features 2 Soft-Close Dampers that will engage when opening and closing the door to provide a smooth, safe operation.

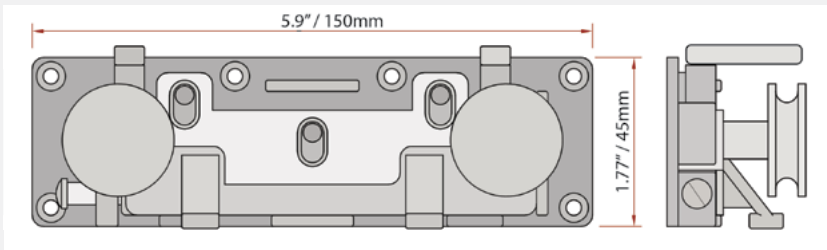

The Houdini Bottom Track includes 4 wheels — 2 wheels on each end of the track. These two pairs of wheels keep the door rolling smoothly even across grout lines on tile floors or joints on a wood floor. This black anodized aluminum Bottom Track can be quickly mounted under the door (Surface Bottom Mount – drawing at left below) or may be mounted inside the bottom edge of the door (Recessed Bottom Mount – drawing at right below) to completely hide the track (drawing at right below). This requires a wood door that is 1-3/4" thick and a routed side-to-side slot in the bottom edge of the door.

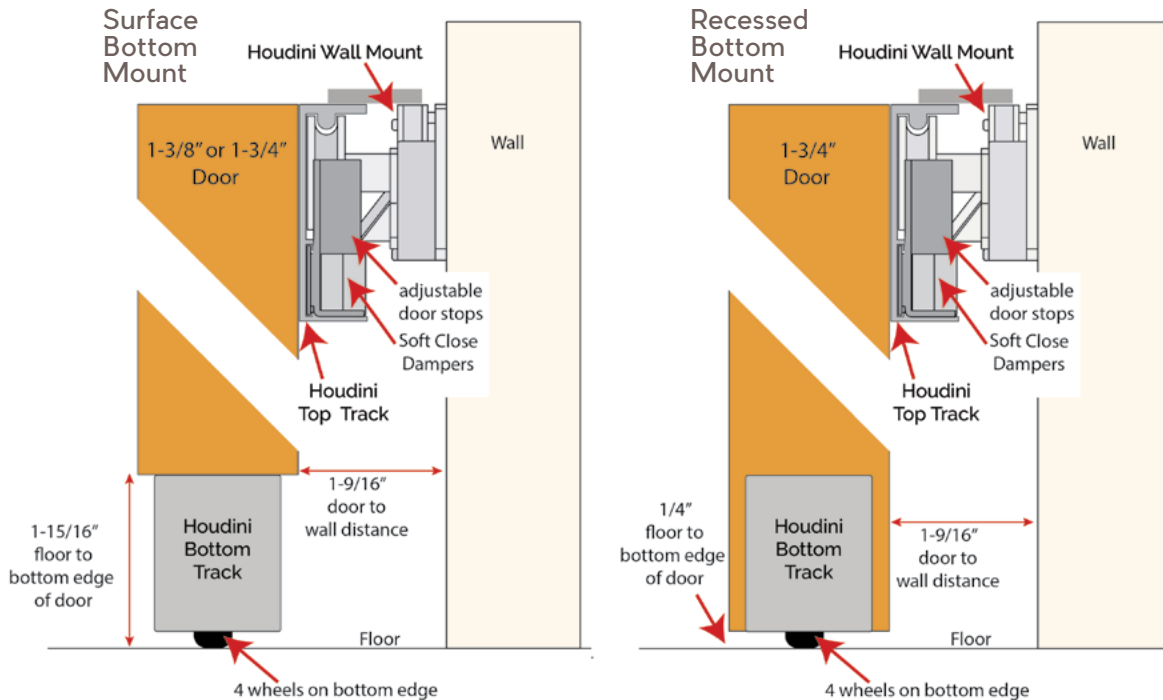

TRADITIONAL or HOUDINI CONCEALED SLIDING DOOR HARDWARE



TRADITIONAL HARDWARE >
Black Slade Traditional sliding hardware shown on a 6'8" tall Inglewood door with Gila pull and Timber Wolf Antique finish.

See door on page 46.
Hardware page 12.

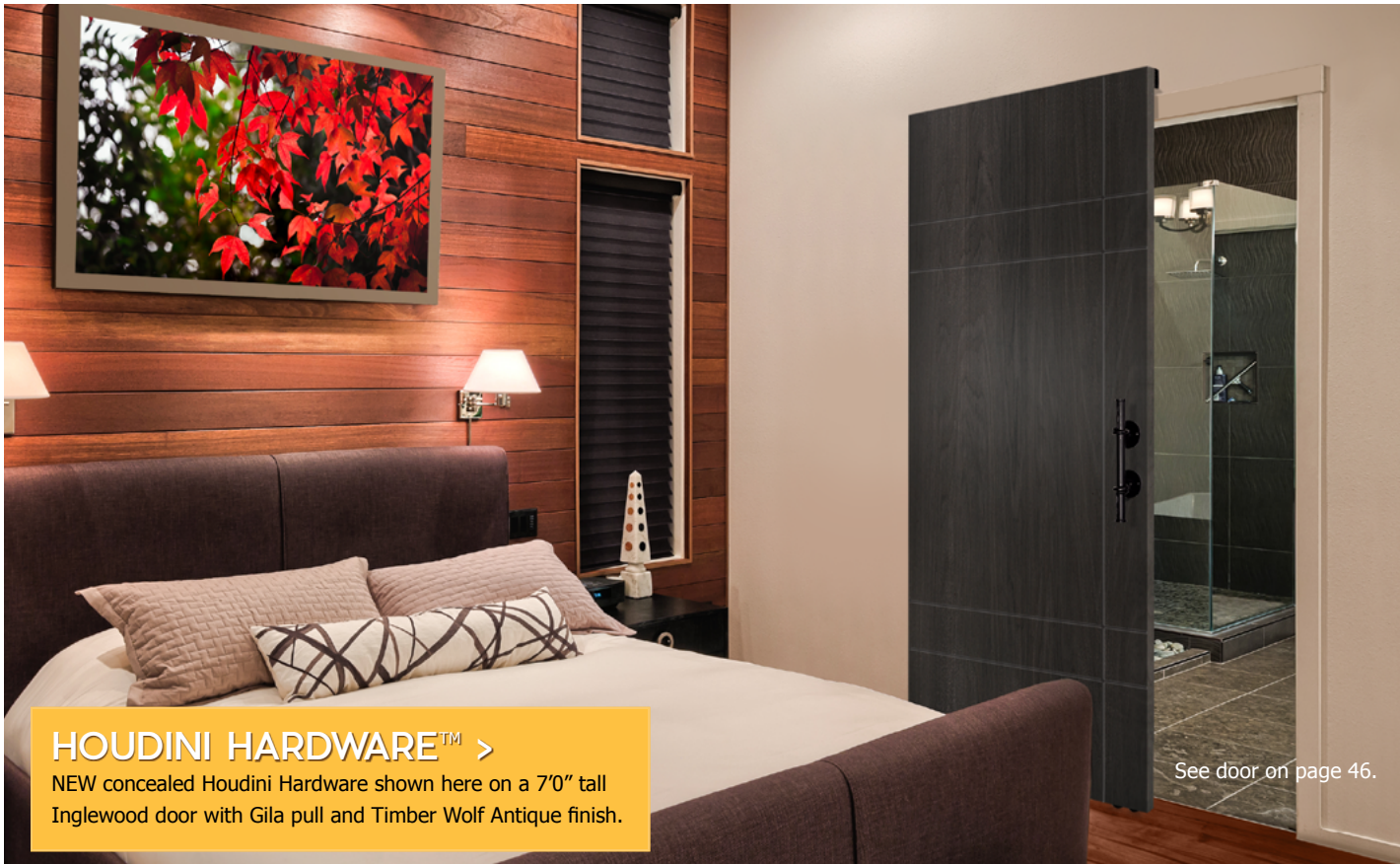

HOUDINI HARDWARE™ >
NEW concealed Houdini Hardware shown here on a 7'0" tall Inglewood door with Gila pull and Timber Wolf Antique finish.

See door on page 46.

Unique HOUDINI Sliding Door Hardware



features **CONCEALED SLIDING HARDWARE**

Pictured on the front cover of this catalog, our patent pending Houdini Hardware™ Kit features concealed rollers and rail, creating an uber-modern minimalist appearance. This system can be mounted and installed in 1 hour. All of the weight of the door is on the floor instead of hanging on the wall. Top Track and Bottom Track are Anodized black aluminum. Two soft-closing dampers provide smooth operation. The Wall Mount has an adjustment feature to ensure a perfect fit between the Rollers and the Top Rail. This hardware has been cycle-tested to 20,000 cycles.

Premium Features:

- Entire system installs onto door & wall in less than 30 minutes for basic installation
- Bottom Track can be recessed into bottom edge of door or quickly surface mounted
- 2 lengths available: Choice of 36" or 48"
- Both Tracks may be trimmed to fit the exact width of your door up to 48" wide.
- May be installed as a single door or a double door
- Weight capacity of door: 175 lbs.
- Houdini Hardware Kit includes all parts listed below and installation guide

2 Houdini Hardware Kits:

Both Tracks may be trimmed for exact fit.

- For doors up to 36" wide **#BDHH36**
- For doors over 36" up to 48" wide **#BDHH48**
- Adapter required for Contemporary Metal doors **#BDHHA**

Houdini Hardware™ Kit Components

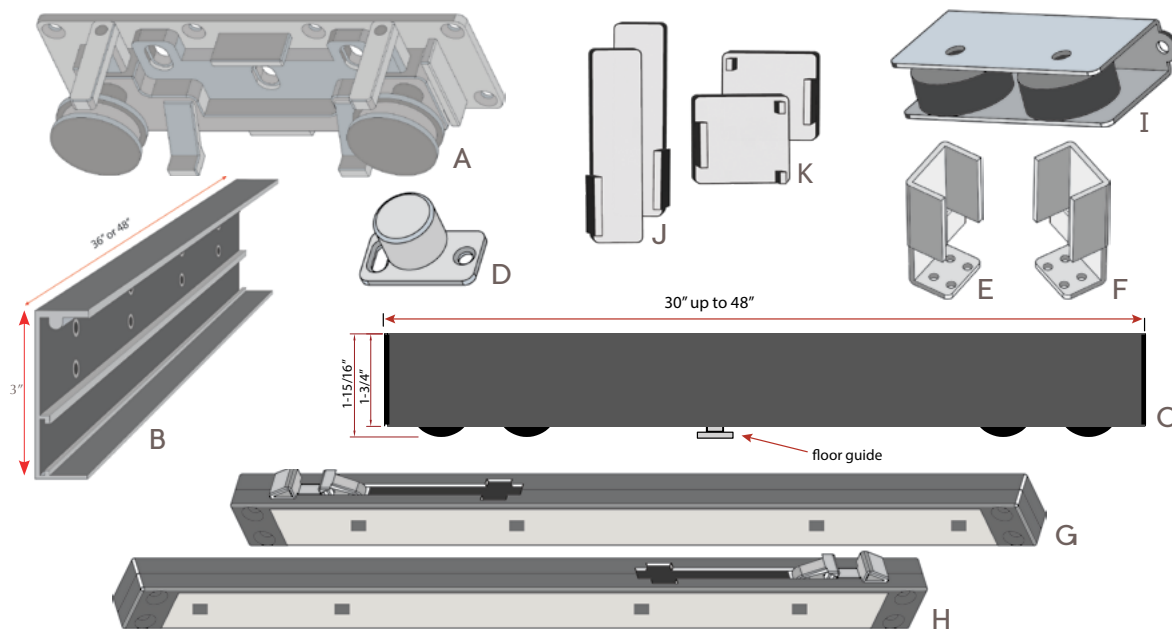

Each HOUDINI HARDWARE KIT* includes:

- A Wall Mount – zinc alloy (x1)
- B Top Track – black anodized aluminum (x1)
- C Bottom Track – black anodized aluminum (x1)
- D Door Floor Guide – carbon steel/plastic (x1)
- E Hard Stop – carbon steel (Left)
- F Hard Stop – carbon steel (Right)
- G Soft Close Damper – plastic and aluminum (Left)
- H Soft Close Damper – plastic and aluminum (Right)
- I Bottom Wheel Assembly – steel/plastic/urethane (x2)
- J Top Track End Caps (x2: Left & Right)
- K Bottom Track End Caps (x2: Left & Right)
- L Set of Fasteners (x1)

What door size is needed for the Houdini Hardware System?

Door size depends upon the size of your opening and the installed location of the Houdini hardware installation. If the door opens completely past the wall opening, or only partially (leaving a few inches of door covering the opening to allow for easier grasp on the door pull on the back side of the door) this will also affect the required door size.

Find additional door size information on page 22.



Unique HOUDINI Sliding Door Hardware



HOUDINI HARDWARE™ >

NEW concealed Houdini Hardware with a surface bottom mount shown here on an 8' Rustic Farmhouse Horizontal door with Gila 24" pull handle.

See door on page 41.



HOUDINI HARDWARE™ >

Houdini Hardware with recessed bottom mount on 8' Continental 5 Lite double door, Cloud glass, Metro 60" pulls and Timber Wolf Antique finish.

See door on page 50.

BARNCRAFT® TRADITIONAL SLIDING DOOR HARDWARE

Premium Traditional Hardware Options



SLADE STAINLESS STEEL HARDWARE KIT
 BDHA01SSK100 - 100" Rail
 BDHA01SSK78 - 78-3/4" Rail



GAGE STAINLESS STEEL HARDWARE KIT
 BDHA02SSK100 - 100" Rail
 BDHA02SSK78 - 78-3/4" Rail

Single Rollers only	
SLADE - stainless steel	#BDHA01SS
GAGE - stainless steel	#BDHA02SS
VINTAGE - black	#BDHA07
SLADE - black	#BDHA01
GAGE - black	#BDHA02
ROYAL - black	#BDHA06
WAGGONER - black	#BDHA03
PHILMONT - black	#BDHA05



SLADE HARDWARE KIT
 BDHA01K100 - 100" Rail
 BDHA01K78 - 78-3/4" Rail



GAGE HARDWARE KIT
 BDHA02K100 - 100" Rail
 BDHA02K78 - 78-3/4" Rail



ROYAL HARDWARE KIT
 BDHA06K100 - 100" Rail
 BDHA06K78 - 78-3/4" Rail



WAGGONER HARDWARE KIT
 BDHA03K100 - 100" Rail
 BDHA03K78 - 78-3/4" Rail



PHILMONT HARDWARE KIT
 BDHA05K100 - 100" Rail
 BDHA05K78 - 78-3/4" Rail



VINTAGE* HARDWARE KIT
 BDHA07K100 - 100" Rail
 BDHA07K78 - 78-3/4" Rail
 * (4-7/8" diameter wheels)

IMPORTANT NOTE:

- * Vintage rollers have wider diameter of 4-7/8". All others have a 2-3/4" diameter wheel.
- ** BarnCraft hardware kits are designed for interior residential doors only. Ensure proper structural support for the rail to the wall for the weight and movement of the door or doors before installation.



TRADITIONAL HARDWARE KIT PARTS

Traditional Hardware features **ADJUSTABLE RAILS & QUIET-GLIDE WHEELS**

Steel mounting rails include an adjustability feature that allows the rails to be perfectly leveled after installation to the walls. Installation of the rails can be difficult to ensure that the rails are perfectly level. But with this unique feature, each rail can be fine-tuned for levelness after the rails have been mounted to the header or directly to the wall. This is an exclusive feature of BarnCraft sliding door hardware.

Premium Features:

- Rollers glide quietly and smoothly on ball-bearings.
- Made of high quality powder-coated steel in black finish with stainless steel options.
- 2 rail lengths available: Choice of 78-3/4" or 100".
- Weight capacity: 220 lbs.
- Kits include the rollers, rail, stoppers, screws & nuts, anti-jump discs, floor guide and installation guide.
- Rollers are available individually and separately from the kit. See page 8 and refer to the online catalog for more information.

Hardware Kits - Adjustable Leveling Rails

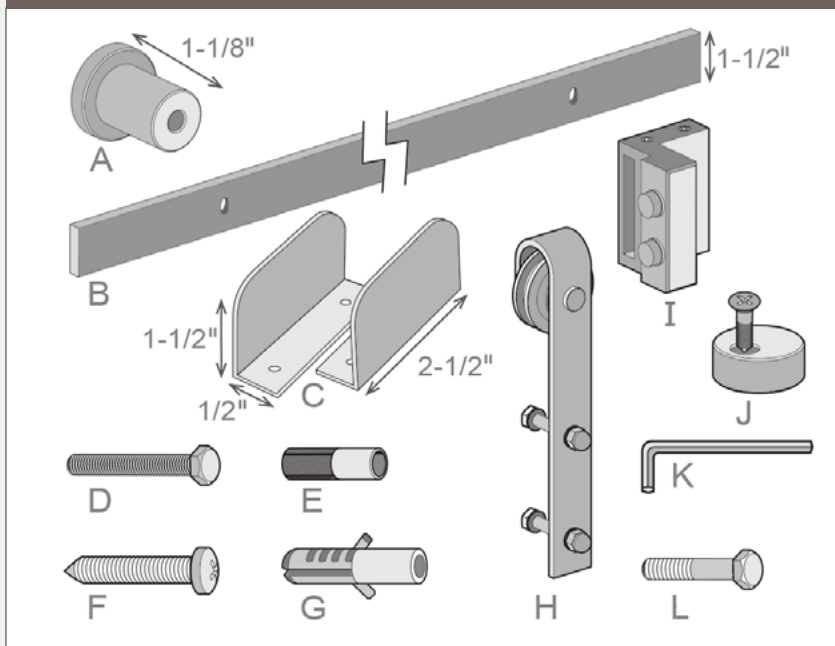

Each **HARDWARE KIT*** includes the following:

- A Stand-off Bracket (x5)
- B Rail (x1) – (see page 10)
- C Door Floor Guide (x1 pair)
- D Bolt (x5)
- E Bolt Wall Anchor (x5)
- F Lag Bolt (x5)
- G Lag Bolt Wall Anchor (x5)
- H Roller (x2) – (see page 8)
- I Stopper (x2)
- J Anti Jump (x2)
- K Allen Wrench (x1)
- L 45 mm Roller Bolt (x6)
(For use on doors thinner than 1-3/4")

Optional:

See pages 15-17 for optional Locks, Pull Handles, and Wall-mount floor guide.

* See page 10 for complete kit information.

- BDPART1 Includes all screws, 2 Anti Jumps (J), 1 Floor Guide pair (C), for black rollers
- BDPART1SS Includes all screws, 2 Anti Jumps (J), 1 Floor Guide pair (C), for stainless steel rollers
- BDPART2 Includes 2 stoppers (I), and Allen Wrench (K), for black rollers
- BDPART2SS Includes 2 stoppers (I), and Allen Wrench (K), for stainless steel rollers
- BDPARTS3 Includes (6) 45 mm Roller Bolts with washers (L), for black rollers
(For use on doors thinner than 1-3/4")
- BDPARTS3SS Includes (6) 45 mm Roller Bolts with washers (L), for stainless steel rollers
(For use on doors thinner than 1-3/4")



SOFT-CLOSE OPTION FOR TRADITIONAL SLIDING DOOR HARDWARE

Soft-Close Damper Option

The Soft-Close option is available for Traditional Sliding Door Hardware Kits.

The soft-close option is an impressive addition to your sliding door installation. Hidden from view, this mechanism ensures a quieter and safer operation of your sliding door by automatically slowing the opening or closing action. No more slamming or jamming issues. Perfect for homes with children, elderly, or those who want ease of use. Packaged 2 per box (one for opening, one for closing), these options attach by set screws directly to the back side of the rail. (These are included with the Houdini Hardware kits). Consider these product features:

- Allows for a safer and smoother operation of the sliding door by automatically slowing the door as it glides gently and quietly into the closed or open position.
- Helps to prevent slamming and accidental jamming of fingers.
- Reduce noise with silent closing/opening action. Ideal for bedroom, bathroom and office installations.
- Use with any of the 6 Black finished sliding door hardware options on page 8. Available in Black finish only.
- Use one for closing action, and a 2nd to open.



SOFT-CLOSE KIT — BDSC (kit includes all parts required)

Please visit www.glasscraft.com/video-resources/ to view a video of the Soft-Close option in action.

Double Door Rail Connector

Consider installing a Rail Connector with your double doors to seamlessly join 2 rails together, end-to-end. The 2 rails appear as one continuous track for a more polished look. Available in black and stainless steel.



BDRC – Black



BDRCSS – Stainless Steel

Door Rail Options

The metal rail used in the BarnCraft door installation is a very heavy duty solid steel flat bar 1-1/2" in height and 1/4" thick. One rail is needed for every door, so a double door installation needs 2 rails. The rail length depends upon the width of the door. The wider the door, the longer the rail needed.

RAIL LENGTH

78-3/4" Rail

100" Rail

Fits Door Widths

up to 36"

38" to 48"

Black Finish

BDRAIL78

BDRAIL100

Stainless Steel Finish

BDRAIL78SS

BDRAIL100SS

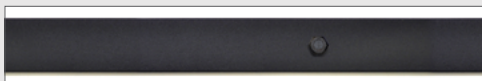

Black Finished Rail

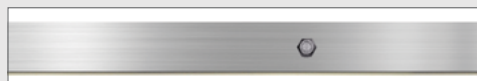

Stainless Steel Finished Rail



HEADER BOARD OPTION FOR TRADITIONAL INSTALLATION

Header Board Options

Installing a Header Board with the BarnCraft hardware kit adds structural support.

The BarnCraft traditional hardware kit is best installed with a header board for added structural support (see examples shown throughout the catalog). With this option, the sliding door hardware is mounted directly to the header board, and the header board mounts to the wall. This method ensures that you can secure this assembly directly into wall studs.

You may use any wood or plywood material for a header board. The Rustic and Barnwood header boards listed below are produced from Knotty Alder and will match your Knotty Alder door. Available finished or unfinished. The White header board option uses a solid wood board with a white laminate that can be used white or painted.

RUSTIC KNOTTY ALDER HEADER BOARD OPTIONS				
	80" Length		108" Length	
	1" x 4" x 80"	1" x 8" x 80"	1" x 4" x 108"	1" x 8" x 108"
Stained - Traditional	BDKAS4S-4-80T	BDKAS4S-8-80T	BDKAS4S-4-108T	BDKAS4S-8-108T
Stained - Distressed	BDKAS4S-4-80D	BDKAS4S-8-80D	BDKAS4S-4-108D	BDKAS4S-8-108D
Stained - Antique	BDKAS4S-4-80A	BDKAS4S-8-80A	BDKAS4S-4-108A	BDKAS4S-8-108A
Unfinished	BDKAS4S-4-80	BDKAS4S-8-80	BDKAS4S-4-108	BDKAS4S-8-108
BARNWOOD HEADER BOARD OPTIONS				
Stained Finish	BDKABWS4S-4-80T	BDKABWS4S-8-80T	BDKABWS4S-4-108T	BDKABWS4S-8-108T
Unfinished	BDKABWS4S-4-80	BDKABWS4S-8-80	BDKABWS4S-4-108	BDKABWS4S-8-108
WHITE HEADER BOARD OPTIONS				
Paintable White	BDKAS4S-4-80M	BDKAS4S-8-80M	BDKAS4S-4-108M	BDKAS4S-8-108M

NO HEADER
(edge view)



WITH HEADER
(edge view)

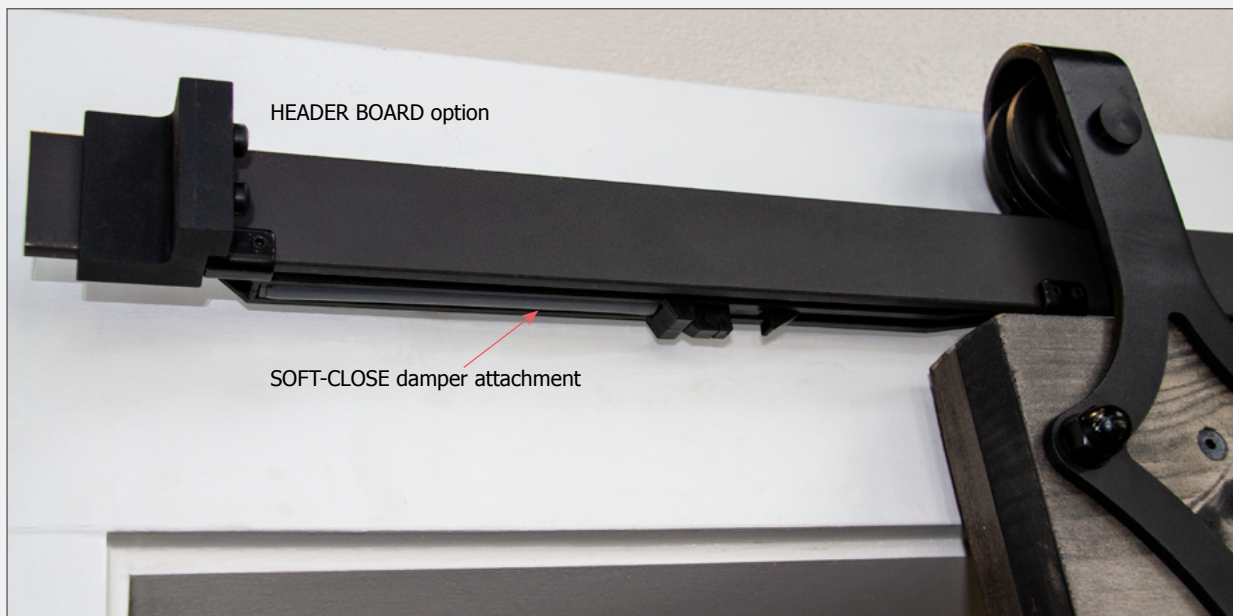
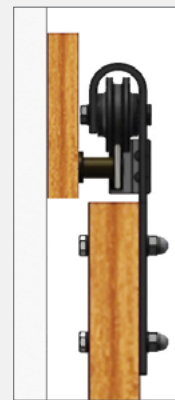

BYPASS OPTION FOR BARNCRAFT® INSTALLATION

Bypass Door Option

The Bypass door installation may be used when there is INSUFFICIENT wall space to the right AND/OR the left of the wall opening. A Bypass Installation uses 2 sliding doors and 2 sliding door tracks instead of one. The second door track is cantilevered in front of the first track, so the doors slide in front of and behind each other.

Photos of this are on page 5. These traditional hardware kits are available in black finish and stainless steel.

For a Double Bypass door installation, you will need 2 doors, 2 traditional sliding door hardware kits, plus 1 of these Bypass Rail Bracket Kits (5 brackets per kit). For a Quadruple Bypass door installation (as shown on page 5), you will need 4 doors, 4 sliding door hardware kits, plus 2 of these bypass rail bracket kits.

Bypass Rail Bracket Kit

BDDPRX Black finish (Set of 5 brackets)

BDDPRSSX Stainless Steel finish (Set of 5 brackets)

Note: Vintage Slider Kits are not compatible with the Bypass Bracket Kits.

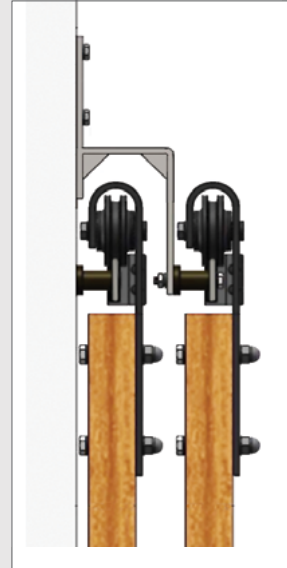

BYPASS RAIL BRACKET
(Stainless Steel option shown)

Left image above: Edge view of double bypass door installation without header. A header may be used which would be installed behind both the inner rail hardware and the outer rail hardware. Black Finish.

Right image above: Stainless Steel option.

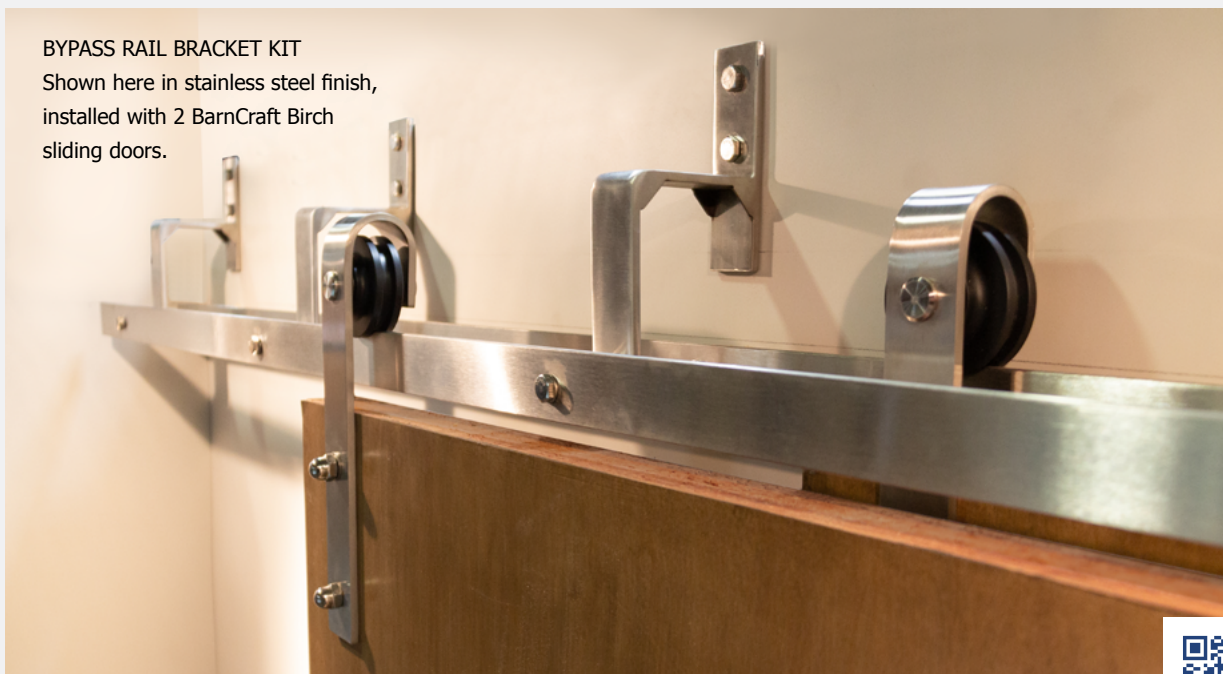

BYPASS RAIL BRACKET KIT
Shown here in stainless steel finish,
installed with 2 BarnCraft Birch
sliding doors.



MORE OPTIONS FOR BARNCRAFT® INSTALLATION

Floor / Wall Guide Options

Every BarnCraft traditional hardware kit includes a "Floor Guide" (at near right). Replacements may also be purchased individually. The optional Wall-Mounted Guide shown at far right mounts to the wall, instead of to the floor. This guide is an option and not included in the hardware kits. Both types are adjustable for different door thicknesses.



BDFG
Floor Guide (replacement for kits – sold individually)



BDWM
Wall-Mounted Guide

Privacy Locks

BarnCraft doors may be installed with a locking system for privacy. Specially designed for the BarnCraft Sliding Doors, the privacy lock is made of premium quality steel. Two colors are available: black powder coated steel or stainless steel. Includes all screws and parts required for installation. Boxed individually. Not for Houdini hardware.

Two sizes are available - Regular and Large. Both will work on all doors, but the Large lock looks and may function better with large doors over 28 square feet. The Regular lock measures about 1.75" x 2.25". The Large lock measures about 3" x 3.25".

Note: GlassCraft will not prep the doors for these locks, as the lock location varies for each specific installation.



BDPL1SS - Regular
Stainless Steel finish



BDPL1 - Regular
Black finish



BDPL2 - Large
Black finish



BDPL2SS - Large
Stainless Steel finish



BARNCRAFT® DOOR HANDLES

Black Pull Handles



Vista (left, 8" tall) - HP4
Prospect (right, 8" tall) - HP26

The black handles shown on this page are made of real hand wrought iron that is durable, heavy, and complements any design theme, together with your choice of BarnCraft door and sliding hardware. As these handles are all hand-made, their size and appearance will vary slightly. All are packaged with mounting screws.

The VISTA mounts flush with the face of the door, and requires a mortise pocket be cut or chiseled into the door for installation. The PROSPECT is 1/4" thick, and mounts directly on the door face, and does not require a mortise pocket. The other handles shown below extend above the face of the door, and can only be mounted on the door face away from the wall. The Vista or Prospect may be mounted on the "back" side of the door. The 12" pull handles directly below are designed to be mounted with the Vista or the Prospect on the "back" side of the door, as the screw holes for each align, but they also may be used separately (without Vista or Prospect).

Refer to our BarnCraft Product & Information Guide for more detail.

12" Pull Handles for 8" Vista or Prospect plate mount

The 5 pull handles at right may be used with or without the Vista pull or Prospect plate, with the 12" handle on the front of the door, and the Vista or Prospect on the back side.



24" Pull Handles



12" Pull Handles

The 6 pull handles below and the 3 to the left all screw directly into the front face of the door.



BARNCRAFT® DOOR HANDLES

Stainless Steel Pull Handles



Vista (Right) (8" tall) - HP4S
Prospect (Left) 8" tall) - HP26S

The stainless steel handles shown on this page and throughout this catalog are made of real stainless steel. As these handles are all hand-made, their size and appearance will vary slightly. All are packaged with mounting screws.

The VISTA pull (shown at near left) and the PROSPECT pull (far left) mount on the face of the door. The Vista requires a mortise pocket be machined or chiseled into the door. The PROSPECT is 1/4" thick, and mounts directly on the door face, and does not require a mortise pocket. The Metro handles extend above the face of the door, and can only be mounted on the door face away from the wall. The Vista or Prospect may be mounted on the "back" side of the door. The Metro is mounted with screws from the back side of the door, which will be visible on the back side.

The 12" and 16" Metro pull handles are designed to be mounted with the VISTA or the PROSPECT on the "back" side, as the screw holes for each align, but they also may be used separately (without the Vista or Prospect).

Refer to our BarnCraft Product & Information Guide for additional specifications and information.



Metro Stainless Steel:
Available in 12", 16", 48", or 60" tall.
The 12" and 16" will fit the Vista pull to mount together, or they may be used separately.



Metro - HP20S
(12" tall)
Stainless Steel

Diameter: 3/4"
Total Length: 12"
Projection: 3"

will fit
VISTA pull.



Metro - HP21S
(16" tall)
Stainless Steel

Diameter: 3/4"
Total Length: 16"
Projection: 3"

will fit
VISTA pull.



Metro - HP48S
(48" tall)
Stainless Steel

Diameter: 1-1/4"
Total Length: 48"
Center to Center
Door Mounting
Distance: 30"
Projection: 3"



Metro - HP60S
(60" tall)
Stainless Steel

Diameter: 1-1/4"
Total Length: 60"
Center to Center
Door Mounting
Distance: 48"
Projection: 3"



TWO FINISH OPTIONS FOR THE BARN DOOR COLLECTION

Barnwood Knotty Alder and Rustic Knotty Alder Textures/Finishes



Option 1. Barnwood Knotty Alder features a distinctive weather-worn Knotty Alder texture with enhanced distressed marks for an authentic barn door look. This high definition texture is available unfinished (raw wood) or showcased beautifully in four factory finish stain options (see below), and heavily textured with knots, occasional holes and/or distress and machine marks. The Barnwood finish is irregular in stain, color and appearance, and features a more heavily textured grain than the Rustic Knotty Alder finish. All colors feature a hand-applied color finish to the natural Knotty Alder wood, which is then distressed with additional distress marks to simulate worm holes, cracks, splits, and wear marks. This finish does not include any clear top coat, so the colors are flat with no sheen or shine.



Option 2. Rustic Knotty Alder features the natural rustic patterns and textures of Knotty Alder as the Barnwood, but without the rough weathered look included in Option 1 above. This Rustic Knotty Alder option is not "smooth" however, and features the occasional "mill mark" and knot hole. This texture is available unfinished (photo at left is the unfinished raw wood) **or** factory finished in several colors as shown on the next 3 pages. The Traditional colors on the next page include the Rustic Knotty Alder texture, the stain color, and a clear urethane satin-sheen top coat. The Antique colors (page 20) are darker, and suggest an aged appearance, and the Distressed colors (page 21) add faux worm holes and cracks to the Antique option for a more rustic aged look. (Distressed and Antique are the same color).

Option 1: Barnwood Texture finish color options

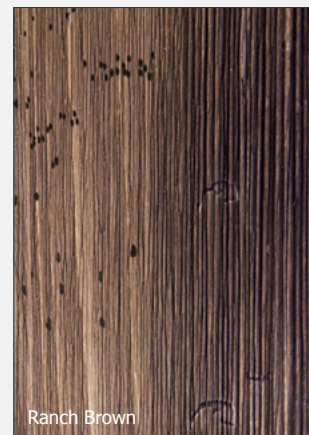
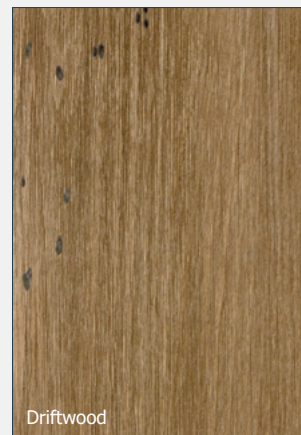

NOTE: The images throughout this catalog showing prefinish options offer an indication of final appearance, but due to variations in the texture, grain and color of the wood, the actual appearance will vary.



Option 2: Rustic Knotty Alder Finish Color Options

Traditional Finish Colors

GlassCraft's nine Traditional finish color options are shown below.

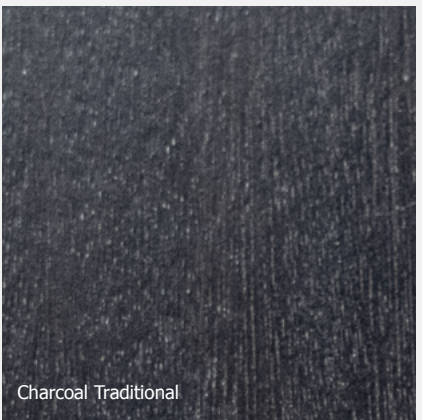

Rustic Knotty Alder Finish Color Options

Antique Finish Color Options

GlassCraft's nine Antique finish color options are shown below.

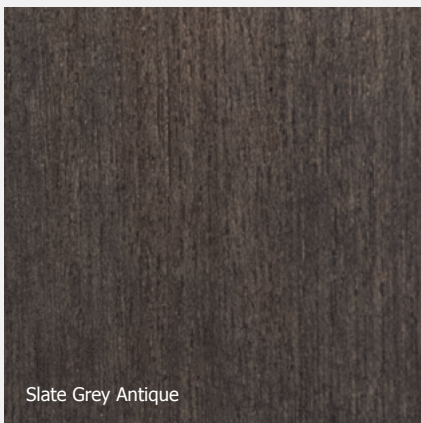
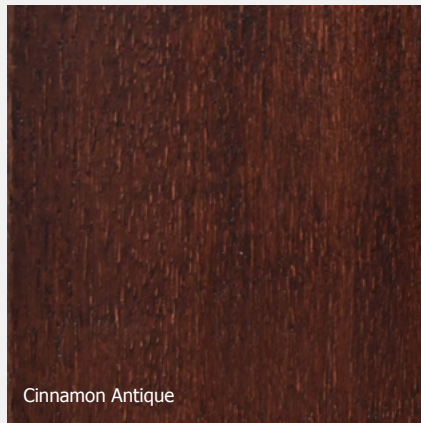
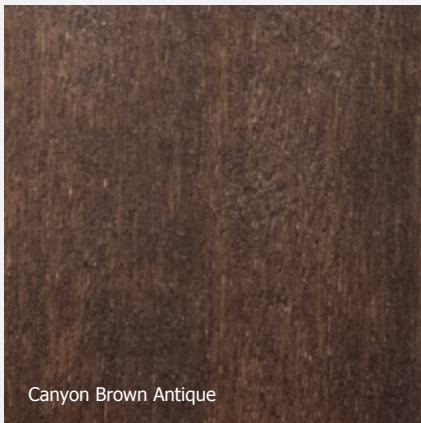
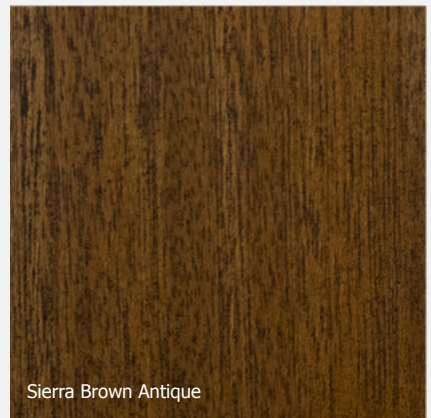

Rustic Knotty Alder Finish Color Options

Distressed Finish Color Options

GlassCraft's Distressed finish color options are shown below. Charcoal (page 19) is also available in the Distressed option.

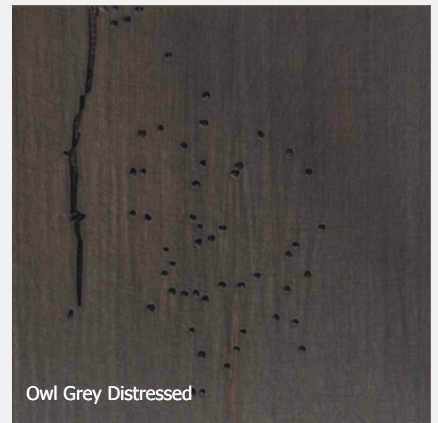
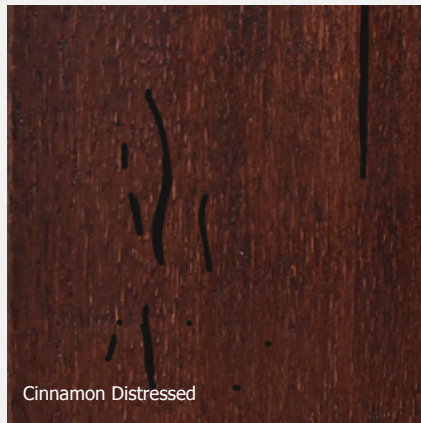
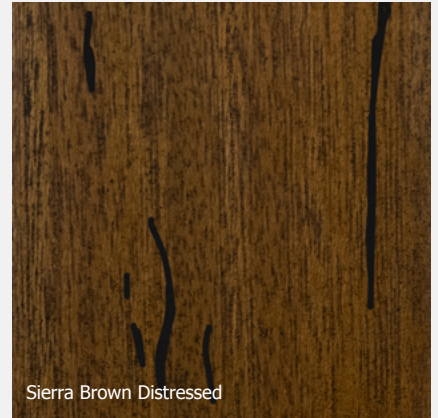

Measuring for your BarnCraft® Door with Traditional Hardware

Determine the minimum door width:

Measure the distance of the inside frame opening and add 4" ($A + 4" = \text{minimum door width}$). This will allow the door to cover the frame opening when the door is fully closed.

Determine the minimum door height:

Measure between the finished floor and the top frame, then subtract 1/2" for floor clearance from the bottom of the door ($B - 1/2" = \text{minimum door height}$). Door may cover the existing door top casing trim if desired, or you may want your door taller than the existing opening. Add on to your door height for this.

Check for minimum door clearance:

A minimum clearance of 6-1/2" (C) is required, measuring from the top edge of the door to the ceiling, to accommodate the track and sliding hardware. The top of the door should be level with or above the frame opening (B).

A minimum clearance of available wall space **equal to the actual door width plus 2"** (D) is required for the door to completely roll free of the door opening.

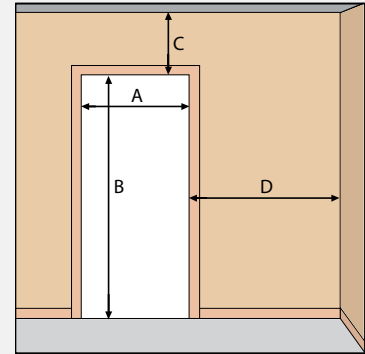

Video Installation Guides:

Video guides are available for the installation of single, double, and bypass sliding doors.

<https://glasscraft.com/video-resources/>



Measuring for a Door with Houdini Hardware™

The Bottom Track (which includes the wheels) may be mounted ON the bottom of the door or IN the bottom of the door (refer to the drawings at the bottom of page 6). The Wall Mount may be mounted overlapping the wall opening making the door handle accessible on the back side of the door. Or the Wall Mount may be located aligned with or evenly spaced back from the edge of the door opening to allow the door to open to the full width or further than the wall opening. Refer to the online installation instructions for the Houdini Hardware for specific guidelines. The door size also depends upon if your wall opening is surrounded by decorative casing or molding. (Casing cannot be more than 5/8" deep).

Determine the minimum door width: Two options — either the door opens to with full width of the wall opening, or the door can partially cover a portion of the wall opening. (For instance, for a bathroom door, you may want 4 to 6 inches of door remaining accessible after opening to easily access the door pull from the bathroom side of the door). To calculate door width to open exposing the full wall opening, then measure the distance of the wall opening and add 7.5" ($A + 7.5" = \text{minimum door width}$. The door can be wider than this). If you want the door to be partially exposed over the wall opening on one side, then deduct the amount to be exposed from 7.5, and add the remainder to the opening width. If you want 7.5" of door to remain exposed, then the door may be the same as the wall opening width.

Determine the minimum door height: For a Bottom Track mounted ON (and not IN) the bottom edge of the door, measure between the finished floor and the top frame (B in the drawing above), then add 1" ($B + 1" = \text{minimum door height}$). The door plus the track will be $B + 3"$ after track installation. IF your door opening has decorative casing, then you will measure from the floor to the top of the casing and add 1" for the minimum door height.

For a completely hidden and concealed hardware appearance, then mount the Bottom Track INSIDE (and not ON) the bottom edge of the door. This requires routing an edge-to-edge slot in the bottom of the 1-3/4" thick door. To determine the door height for this installation, measure between the finished floor and the top frame (B), then add 3" ($B + 3" = \text{minimum door height}$). The door plus the track will be $B + 3"$ after track installation. IF your door opening has decorative casing, then measure from the floor to the top of the casing, and add 3" for the minimum door height.

ADDITIONAL INFORMATION

Warranty

The BarnCraft Collection is backed by our guarantee of craftsmanship and premium quality. GlassCraft offers a limited 1 Year door warranty on all BarnCraft sliding doors.

GlassCraft also provides its BarnCraft hardware with a guarantee of durability. Produced with strong steel and quiet-gliding operation, the BarnCraft traditional sliding door hardware and Houdini Hardware both come with a limited 5 Year warranty.

Visit www.glasscraft.com for more information.

BarnCraft Door Dimensions

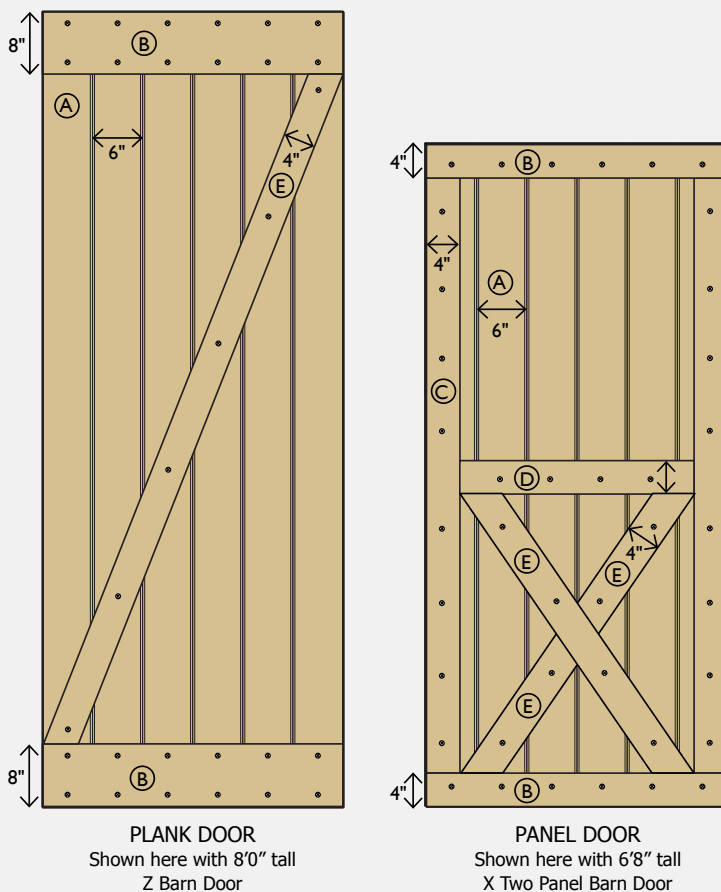

- A – Tongue-and-groove Plank 6" width
- B – Cross Rail 8" height (Plank style doors only)
4" height (Panel style doors)
- C – Vertical Brace 4" width (Panel style doors only)
- D – Horizontal Brace 4" height (Panel style doors only)
- E – Diagonal Brace 4" width



FAQs:

- 1) **What is the thickness of the Barn Doors?** 3/4" thick doors + 1" thick rails for a total door thickness of 1-3/4" for the Pine or Knotty Alder Barn Door series. Other door series vary in door thickness. Please check those section pages.
- 2) **How do we determine which track length is needed?** We recommend the 78-3/4" track for door width of up to 36". For door widths of 38" up to 48" wide we suggest the 100" rail length. Double doors or by-pass doors require more than 1 rail. No tracks used on Houdini Hardware.
- 3) **Will the Hardware work with other doors that GlassCraft offers?** Yes. Visit our website at www.glasscraft.com to view other doors.
- 4) **Is the hardware all metal and are the rollers Nylon?** The wheel part of the rollers on traditional hardware are Nylon which provides the Quiet-Glide benefit. All other parts are powder-coated solid metal. Wheel axles include ball-bearings. Houdini Hardware uses Urethane wheels.
- 5) **What does the back of the barn door look like?** The Pine or Knotty Alder Barn Door series are constructed from planks of Pine or Knotty Alder wood or Knotty Alder Barn Wood. The back side will be stained or painted in the same finish as the front. If the doors come with rails or braces, these pieces will be on the front side where the rollers are facing. The MDF door series has the Design on both sides.
- 6) **What are the dimensions of the Knotty Alder barn doors?** See the diagrams at left. Other door series have different dimensions. The Iron plank doors all use 6" planks. The MDF doors, birch doors, and Mahogany doors vary according to door width, height, and design.



36" wide x 96" tall Rustic Knotty Pine Double Z Two Panel Barn Door shown here with black Slade hardware and Corona pull handle.

RUSTIC KNOTTY PINE

The Knotty Pine Barn Door Collection is available unfinished (no paint or stain) only. These true plank doors are the most economical of all of the BarnCraft doors. Knotty Pine features random knot holes, mineral streaks, and the occasional check or minor crack. 3/4" thick planks: 1-3/4" thick at cross rails.



Available in 8 door designs and two heights.

These Pine Barn Door may be ordered in any of the 8 styles, at heights of either 7'0" or 8'0" tall.

These doors are only available unfinished, ready for your paint or stain. Doors will require sanding prior to your finish process.

These doors are also available in a Quick Ship Kit that includes the black SLADE hardware (see next page).

These doors use
**TRADITIONAL HARDWARE
ONLY**

KNOTTY PINE BARN DOOR COLLECTION

BARNCRAFT® PREMIUM SLIDING DOORS

PINE BARN DOOR & HARDWARE KIT

In Stock and Ready-to-Ship!

This kit includes a 36" wide pine door and Slade traditional hardware kit, plus other bonus components that make for an easy and ready-to-install product.

PREMIUM FEATURES:

- Includes a stainable, ready-to-paint Knotty Pine barn door showing a mid-rail design on Side 1, and a one-panel design on Side 2.
- Available in 7'0" or 8'0" height, and 36" wide.
- Includes high-quality Slade black hardware kit with 78-3/4" long steel rail and all required mounting hardware. Door is pre-drilled specifically for the Slade hardware.
- Includes matching unfinished header for a more secure mounting and easier installation.
- 8 Doors in One! Includes bonus wooden parts that are sanded and pre-cut to configure the doors in any of the barn door designs below.
- Smart Packaging: All included pieces fit into one ready-to-ship, secure box with hardware components packed individually inside.



8 Doors in 1! — Use bonus pre-cut bars to configure the barn door in any of these designs:

8'0"

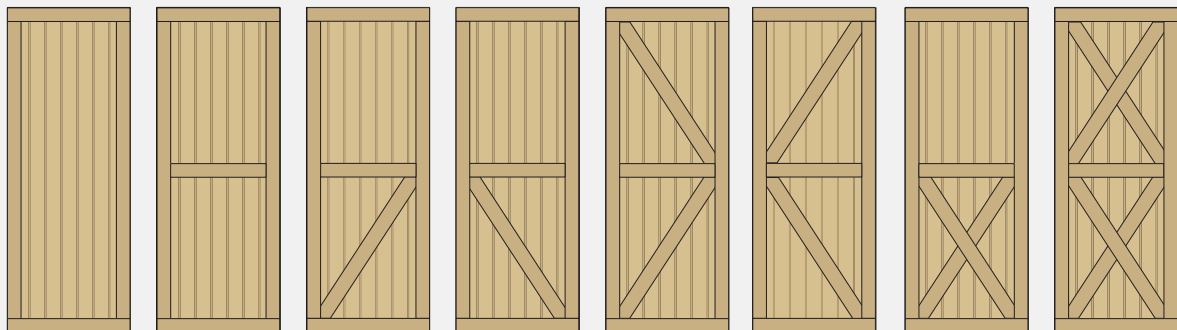

One Panel

Two Panel

Half Z Right

Half Z Left

Double Z Right

Double Z Left

X One Panel

X Two Panel

7'0"

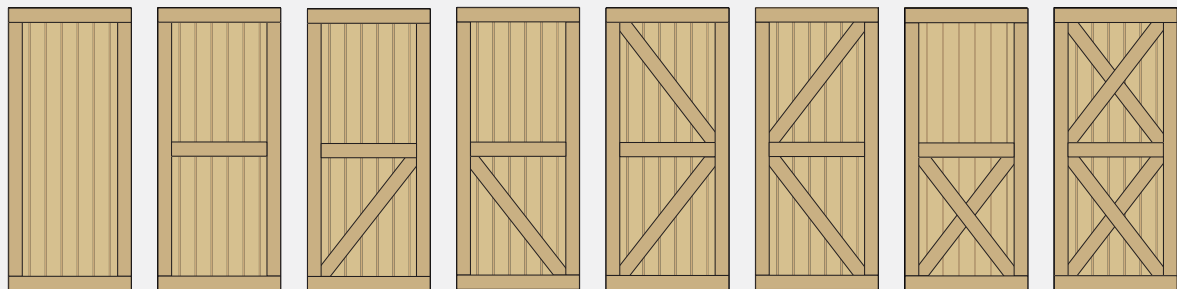

Side 1



Side 2



7'0" Quick Ship Kit

(Includes 36" Knotty Pine unfinished door, Slade hardware kit, header, bonus pre-cut bars, mounting screws and bolts)

8'0" Quick Ship Kit

(Includes 36" Knotty Pine unfinished door, Slade hardware kit, header, bonus pre-cut bars, mounting screws and bolts)



KNOTTY PINE BARN DOOR COLLECTION

1 Panel/2 Panel Barn Door

This Knotty Pine door features a "1 Panel" design on one side, and a "2 Panel" design on the other. Use either side for the "front". Doors are all 36" wide and available in either 7'0" or 8'0" tall options. Door options include 8 sliding door hardware choices and a variety of door pulls. Hardware sold separately. Unfinished only – no finish options.



Double Z Barn Door (left or right)

This Knotty Pine door features a "Double Z" design on both panels on one side of the door, and a "1-Panel" design on the back side. Doors are all 36" wide and are available in either 7'0" or 8'0" tall options. Door options include 8 sliding door hardware choices and a variety of door pulls. Hardware sold separately. Unfinished only – no finish options. Order options are: "right" or "left".



Half Z Barn Door (left or right)

This Knotty Pine door features a "Half Z" design on the lower panel on one side of the door, and a "1-Panel" design on the back side. Doors are all 36" wide and are available in either 7'0" or 8'0" tall options. Door options include 8 sliding door hardware choices and a variety of door pulls. Hardware sold separately. Unfinished only – no finish options. Order options are: "right" or "left".



X One Panel Barn Door

This Knotty Pine door features an "X" design on the lower panel on one side of the door, and a "1-Panel" design on the back side. Doors are all 36" wide and are available in either 7'0" or 8'0" tall options. Door options include 8 sliding door hardware choices and a variety of door pulls. Hardware sold separately. Unfinished only – no finish options.



X Two Panel Barn Door

This Knotty Pine door features an "X" panel on both the upper and lower panels on 1 side, and a "1 Panel" design on the back. Doors are all 36" wide and are available in either 7'0" or 8'0" tall options. Door options include 8 sliding door hardware choices and a variety of door pulls. Hardware sold separately. Door sold unfinished only.





48" x 84" Barnwood Knotty Alder door with Double X design, Driftwood finish, black Gage hardware and Vista inset pull.

RUSTIC or BARNWOOD

The Alder Barn Door Collection is available in two different Knotty Alder textures. Rustic texture Knotty Alder is available in Unfinished, Traditional, Distressed and Antique finish options. Barnwood texture Knotty Alder features specialty finishes and heavy distress marks for an authentic weathered barn wood look and design. 3/4" thick planks: 1-3/4" thick at cross rails. See pages 28-29 for available door styles, sizes, details and options.

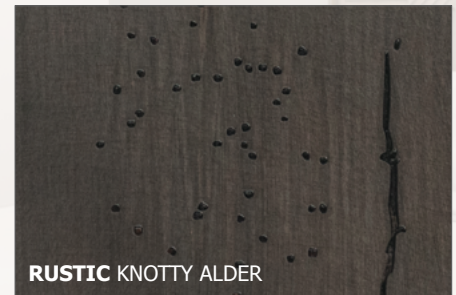

RUSTIC KNOTTY ALDER

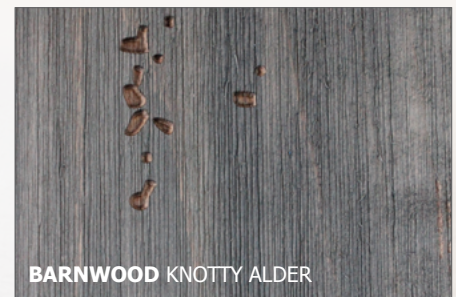

BARNWOOD KNOTTY ALDER

These doors may use
TRADITIONAL or HOUDINI
HARDWARE

The Barn Door Design Series features Knotty Alder wood in two textures: Rustic Knotty Alder with the characteristic closed pore graining and natural wormholes, pits, and crack patterns; and the Barnwood Knotty Alder with enhanced distressed markings and a more pronounced, raised grain for an authentic weathered barnwood look. Available in 8 door designs and various sizes.

All doors in this series use real 6" wide Pacific Northwest American Knotty Alder tongue-and-groove wood planks that are 3/4" thick. The 1" thick wooden cross rails or slanted rails are mounted on one side of the door and not on both sides. Total door thickness at rails is 1-3/4". See page 23 for more barn wood dimensions and details.

The Barn Door Series may be ordered in 6" width increments, from 24" wide to 60" wide, while heights are available from 80" to 96" in 2" increments. Not all of the 8 door profiles are available in all sizes.

KNOTTY ALDER BARN DOOR COLLECTION

BARNCRAFT® PREMIUM SLIDING DOORS

KNOTTY ALDER BARN DOOR COLLECTION

Plank Barn Door



36" wide x 96" tall. Shown with Barnwood Ranch Brown finish, Slade stainless steel hardware, and Metro stainless steel 48" pull.

Z Barn Door



36" wide x 96" tall. Shown with Winter Distressed finish, Royal hardware, and optional Corona pull handle.

Mid Rail Plank Barn Door



42" wide x 96" tall. Shown here with Barnwood White Wash finish, Royal hardware, and optional Vista inset pull handle.

Double Z Two Panel Barn Door



36" wide x 96" tall. Shown here unfinished, with Philmont hardware and optional Tucson 24" pull handle.

Plank

Height: 80" Minimum
96" Maximum

Width: 24" Minimum
48" Maximum

This door is available in sizes from 24" wide x 80" tall, up to 48" wide x 96" tall, in 6" increments of width, and 2" increments of height.

Z

Height: 80" Minimum
96" Maximum

Width: 24" Minimum
60" Maximum

This door is available in sizes from 24" wide x 80" tall up to 60" wide x 96" tall, in 6" increments of width, and 2" increments of height.

Mid Rail Plank

Height: 80" Minimum
96" Maximum

Width: 24" Minimum
60" Maximum

This door is available in sizes from 24" wide x 80" tall up to 60" wide x 96" tall, in 6" increments of width, and 2" increments of height.

Double Z Two Panel

Height: 80" Minimum
96" Maximum

Width: 24" Minimum
48" Maximum

This door is available in sizes from 24" wide x 80" tall up to 48" wide x 96" tall, in 6" increments of width, and 2" increments of height.

Please refer to our on-line catalog and the new DoorCrafter tool for additional information and pricing for these doors.

These doors may use
**TRADITIONAL or HOUDINI
HARDWARE**

All Knotty Alder doors are available in your choice of sizes at no additional cost. These doors are sold by the square foot.



KNOTTY ALDER BARN DOOR COLLECTION

Double X Barn Door



36" wide x 84" tall. Shown here with Natural Distressed finish, Waggoner hardware, and optional Gila pull handle.

Double Z Barn Door



36" wide x 80" tall. Shown with Owl Grey Distressed finish, black Slade hardware, and optional San Juan 24" pull handle.

Two Panel Barn Door



32" wide x 96" tall. Shown with Canyon Brown Traditional finish, stainless steel Gage hardware, and optional Vista pull handle.

X Two Panel Barn Door



42" wide x 96" tall. Shown here with Barnwood Ranch Brown finish, Vintage hardware, and optional Gila 24" pull.

Double X

Height: 80" Minimum
96" Maximum

Width: 24" Minimum
60" Maximum

This door is available in sizes from 24" wide x 80" tall up to 60" wide x 96" tall, in 6" increments of width, and 2" increments of height.

Double Z

Height: 80" Minimum
96" Maximum

Width: 24" Minimum
48" Maximum

This door is available in sizes from 24" wide x 80" tall up to 48" wide x 96" tall, in 6" increments of width, and 2" increments of height.

Two Panel

Height: 80" Minimum
96" Maximum

Width: 24" Minimum
60" Maximum

This door is available in sizes from 24" wide x 80" tall up to 60" wide x 96" tall, in 6" increments of width, and 2" increments of height.

X Two Panel

Height: 80" Minimum
96" Maximum

Width: 24" Minimum
60" Maximum

This door is available in sizes from 24" wide x 80" tall up to 60" wide x 96" tall, in 6" increments of width, and 2" increments of height.

Please refer to our on-line catalog and the new DoorCrafter tool for additional information and pricing for these doors.

These doors may use
**TRADITIONAL or HOUDINI
HARDWARE**

All Knotty Alder doors are available in your choice of sizes at no additional cost. These doors are sold by the square foot.





36" wide x 96" tall Vertical Iron Plank Rustic Knotty Alder door with Owl Grey finish, black Slade sliding hardware, and Gila pull handle.

IRON PLANK

The Iron Plank Collection is available in two different Knotty Alder textures: Rustic texture Knotty Alder with Traditional, Antique and Distressed finish options, and Barnwood texture with distress marks. Planks are 3/4" thick solid wood with a 1.125" metal frame. Please see page 31 for available door styles, details and options.

Note: Doors are identical in appearance on both sides of the door.



RUSTIC KNOTTY ALDER

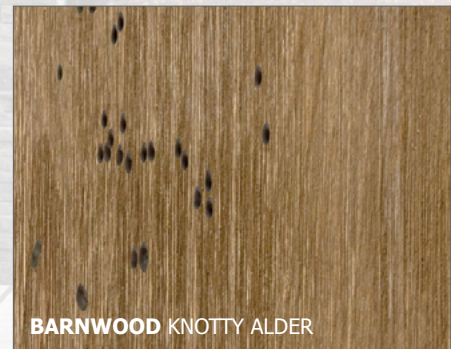

BARNWOOD KNOTTY ALDER

These doors use
**TRADITIONAL HARDWARE
ONLY**

IRON PLANK COLLECTION

BARNCRAFT® PREMIUM SLIDING DOORS

THE IRON PLANK BARNCRAFT® COLLECTION

Vintage Industrial Look

The Iron Plank door features solid Knotty Alder planks surrounded with a black-steel border. The collection, sold by the square foot, offers a choice of multiple stain and paint options and a variety of sizes.

FEATURES:

- Available in Rustic Knotty Alder and Barnwood finish options (see pages 18-21).
- Available with either vertical or horizontal plank options.
- Metal door edge is 1.125" in thickness, and is powder coated in a flat black finish.
- Knotty Alder door planks are 3/4" thick.
- Available assembled only.

Complement these Iron Plank sliding doors with BarnCraft hardware kits and handles. See page 10 for all available BarnCraft sliding hardware options and pages 16-17 for all pull handles.

Horizontal Iron Plank Door

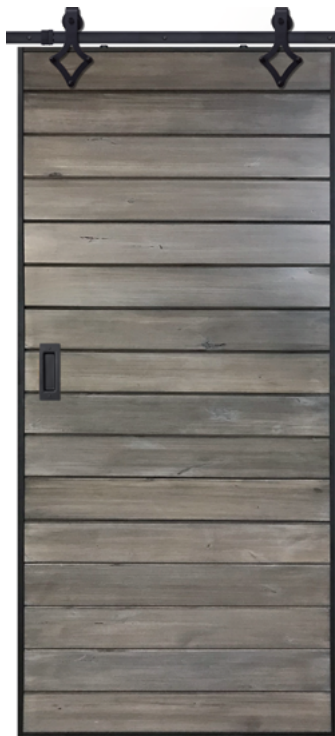

42" wide x 96" tall. Shown with Winter Antique finish, Royal hardware, and Vista pull handle.

Vertical Iron Plank Door



36" wide x 96" tall. Shown with Owl Grey Antique finish, Slade hardware, Vista pull.

Horizontal Iron Plank

Height: 84" Minimum 96" Maximum
Width: 24" Minimum 48" Maximum

This door is available in sizes from 24" wide x 84" tall up to 48" wide x 96" tall, in 2" increments in **width** and in 6" increments in **height**.

Vertical Iron Plank

Height: 80" Minimum 96" Maximum
Width: 24" Minimum 48" Maximum

This door is available in sizes from 24" wide x 84" tall up to 48" wide x 96" tall, in 6" increments in **width** and in 2" increments in **height**.

Please refer to our on-line catalog and the new DoorCrafter tool for additional information and pricing for these doors.





36" wide x 96" tall BarnCraft MDF door in the Flush design (page 36) with Softened Green paint finish, black Gage sliding hardware and a black 24" Gila pull handle.

CARVED MDF up to 9' Tall

The MDF Door Collection is produced using MDF (Medium Density Fiberboard). These doors are router-carved into various beautiful door designs. MDF doors are primed in smooth white (for your paint application) or painted in any of 9 popular colors. Please see pages 36-37 for available door styles, details and options.

PAINTABLE

PRIMED WHITE MDF

These doors may use
**TRADITIONAL or HOUDINI
HARDWARE**

MDF COLLECTION

BARNCRAFT® PREMIUM SLIDING DOORS

THE MDF BARNCRAFT® COLLECTION

MDF Doors in Primed White or Paint Colors

The MDF BarnCraft Collection features 1-3/8" thick doors that are produced using MDF (Medium Density Fiberboard). These doors are certified to CARB standards. They are available in 2 finish options: 1) with a white primed finish (ready for your own paint color or 2) with a factory-applied paint finish from our Pallete Collection.

MDF doors are available with no design (flush door) or with the door design router-carved on both sides of the door.

All BarnCraft sliding door hardware may be used on these doors, see pages 6-10 for available BarnCraft sliding hardware options.

MDF doors are available in 4 door heights: 80", 84", 96", 108" and in 4 widths: 32", 36", 42", and 48".

There are 14 different MDF door designs available, in 16 different sizes and 10 different colors.



42" wide x 96" tall. Shown with Shoji White paint finish, Vintage hardware and Gila 24" pull handle.



Photo: Shown with 36" wide x 80" tall BarnCraft MDF Shaker 5 Panel door (page 37) with Gale paint color, Slade stainless steel sliding hardware, and Metro 60" pull handle.

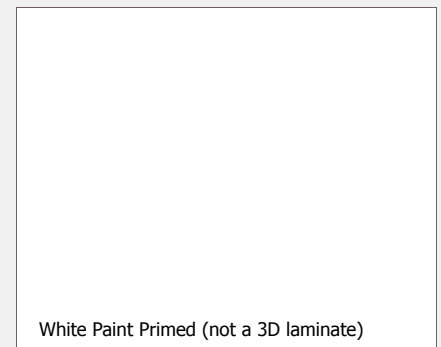

White Paint Primed (not a 3D laminate)

The White Paint Primed should be painted the color of your choice.

PAINT Finish PALETTE COLLECTION™ for MDF & Contemporary

Palette Collection Paint Finish Options for MDF and Contemporary Birch Doors

Nine trending colors are offered in GlassCraft's **Palette Collection** of paint colors for our BarnCraft MDF and Contemporary Birch doors. Each year, paint companies and color experts reveal their picks for the shade that best encapsulates current trends. Their choices for color of the year often draw on trends in pop culture, fashion, technology, and design from around the world. The nine colors in our Palette Collection are all top trending colors for use on these MDF doors.

GlassCraft's door paint is a protective monochromatic coating specifically formulated for use on exterior and interior surfaces. A single-component, water-borne, acrylic coating formulated for direct application, it exhibits outstanding adhesion properties, eliminating the need for a primer coat.

Please Note: The photos on these pages and throughout this catalog offer an indication of the actual appearance of the colors, but due to variations in the texture, grain pattern, and colors used in this hand-finished process, the actual appearance will vary.



36" wide x 80" tall BarnCraft MDF door in the X Blackboard design (page 37) in Rookwood Terra Cotta Palette color finish, with black Slade sliding hardware and a Gila pull handle.

Palette Collection Color Name & Description:

- **Arcade White**... think of a cup of milk with a dash of coffee, creating an inviting and warm door or entryway.
- **Shoji White** is a warm white, with greige (beige and gray) undertones. It has a nice creaminess to it, but its greige undertones keep it from looking too yellow. It won't end up looking cold on a door even if it's facing north or east.
- **Softened Green**... a popular trending color, softened green is the perfect neutral green paint color and looks great with white and black accents.
- **Grey Clouds** is a neutral, midtone grey that may tend to the warmer side.
- **Gale Force**... a darker, neutral, emerald aqua-green with a hint of blue undertone. Perfect for a door with some drama.
- **Rookwood Terra Cotta** is a warm pastel red-orange which offers an old, earthy feel for a different yet unique focal point.
- **Urbane Bronze** is a deep taupe color... essentially a dark brown with an added grey aspect, which gives it a green undertone in bright lighting. It's earthy core gives off a comforting warmth.
- **Perle Noir** ... a rich charcoal color, and is a good paint choice if you are looking to add drama to your door with some sophistication.
- **Tricorn Black** has no discernible undertones and it's truly a neutral paint color. If you're looking for a true black, go with Tricorn Black.

PAINT Finish PALETTE COLLECTION™

Palette Collection Paint Finishes for MDF & Contemporary Birch Doors

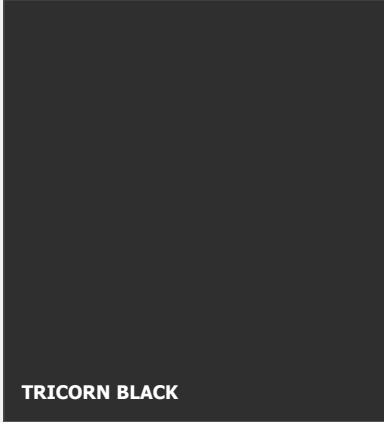
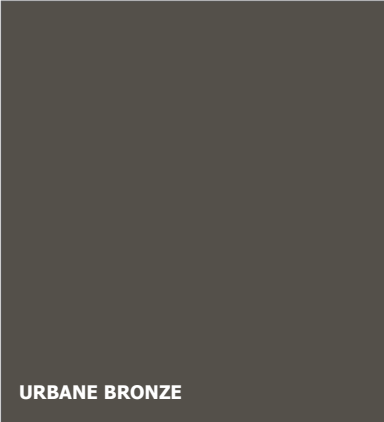
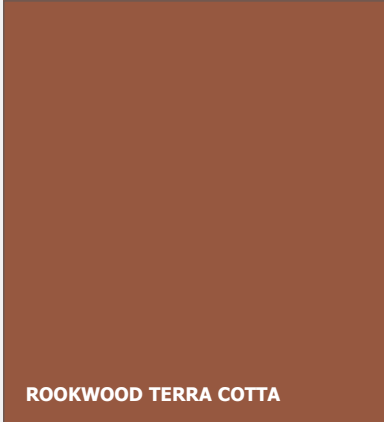
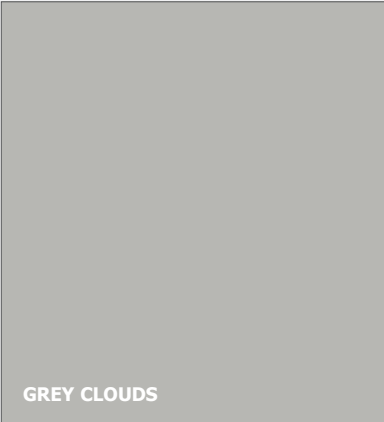
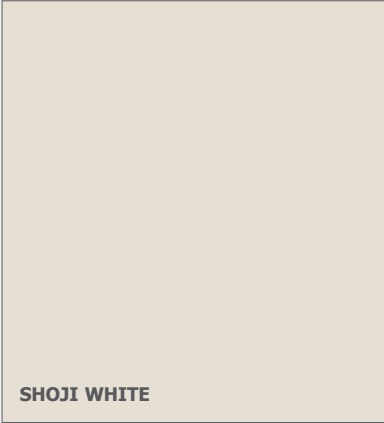

Please Note: The photos on this page and throughout this catalog offer an indication of the appearance of the colors, but due to variations in the printing process, the actual appearance of the color may vary.



THE MDF BARNCRAFT® COLLECTION

Chevron MDF Door 2 Panel Chevron MDF Door Lynnwood MDF Door Flush MDF Door



42" wide x 96" tall. Shown here with Softened Green paint, Slade stainless steel hardware and 48" Metro pull.

42" wide x 96" tall. Shown with Shoji White paint finish, Vintage hardware and Gila 24" pull handle.

42" wide x 96" tall. Shown in Softened Green paint with Royal hardware and San Juan 24" pull handle.

36" wide x 96" tall. Shown with Gale Force paint finish, Stainless Steel Gage hardware and 48" Metro pull.

Brentwood MDF Door 1 Panel Plank MDF Door Full Plank MDF Door



36" wide x 96" tall. Shown with Arcade White paint finish, Gage stainless steel hardware and 48" Metro pull.

36" wide x 96" tall. Shown painted Shoji White, with Gage hardware and Del Mar pull.

42" wide x 108" tall. Shown here with Perle Noir paint finish, black Slade hardware and Metro 60" pull.

MDF Doors above are available in 4 heights:
80", 84", 96" and 108".
And in 4 widths 32", 36", 42", and 48".

These doors may use
TRADITIONAL or HOUDINI
HARDWARE



THE MDF BARNCRAFT® COLLECTION

Craftsman 1 Panel
MDF Door



36" wide x 96" tall. Shown with Grey Clouds paint finish, Gage stainless steel hardware and 60" Metro pull.

Craftsman MDF Door



36" wide x 96" tall. Shown here with Rookwood Terra Cotta paint finish Vintage hardware and San Juan 24" pull.

Shaker 3 Panel
MDF Door



36" wide x 96" tall. Shown here with Arcade White paint finish, Philmont hardware and Corona pull.

Shaker 5 Panel
MDF Door



42" wide x 96" tall. Shown with Gale Force paint finish, and stainless steel Gage hardware and Metro 16" pull.

2 Panel MDF Door
(with or without V-Grooves)



36" wide x 96" tall. Shown unfinished with white primer, Philmont hardware and Gila 24" pull handle.

Triple X MDF Door



36" wide x 96" tall. Shown with Grey Clouds paint finish, Gage hardware and Tuscon 24" pull handle.

X Blackboard MDF Door



36" wide x 96" tall. Shown with Rookwood Terra Cotta paint finish, Vintage hardware and Gila pull.

MDF Doors above are available in 3 heights:
80", 84", and 96".
And in 4 widths 32", 36", 42", and 48".

These doors may use
**TRADITIONAL or HOUDINI
HARDWARE**





36" wide x 96" tall Rustic Farmhouse door with Chevron 3 design (see page 40), Royal sliding hardware and Concord pull handle. Plank colors used are Weathered White, Sandy Beach, Riverwood and Barnwood.

RUSTIC FARMHOUSE

The Rustic Farmhouse Door Collection features rustic wood planks adhered to one or both sides of a solid door. Produced using an engineered door core, these barn doors are dense, heavy and long lasting. The added real wood planks are produced from strong Canadian pine and available in eight distinctive colors (see next page).

All BarnCraft sliding door hardware may be used on these doors, see pages 6-10 for all available BarnCraft sliding hardware options.



Closeup photo: Black edge molding on the Rustic Farmhouse doors. Doors with planks on the front side only, have a Birch skin on the back.

These doors may use
**TRADITIONAL or HOUDINI
HARDWARE**

RUSTIC FARMHOUSE COLLECTION

BARNCRAFT® PREMIUM SLIDING DOORS

THE RUSTIC FARMHOUSE BARNCRAFT® COLLECTION

Natural Wood Plank Design

Each Rustic Farmhouse door is approximately 1-1/2" thick with the 2 vertical edges of the door covered with a thin black molding. The plank designs may be added to one or both sides of the door. Doors with planks on both sides are thicker than those with planks on one side. Doors are available in 1-color or multi-color combinations (see next page).

All sliding door hardware options are available for all doors in this series. See pages 6-10 for all hardware designs (hardware not included with the purchase of this door and should be ordered separately).

The Rustic Farmhouse Collection doors are available in 3 door heights: 80", 84" and 96", and in up to 4 door widths: 32", 36", 42", and 48".

- Available pre-finished only
- Real wood planks made from kiln dried Canadian pine
- Two different door designs in 8 plank colors or combinations
- Solid Core doors
- Sliding hardware sold separately



Stormy Grey



Cloudy Grey



Barnwood



Sandy Beach



Charcoal Dusk



Riverwood



Weathered Brown



Weathered White



THE RUSTIC FARMHOUSE BARNCRAFT® COLLECTION

Rustic Farmhouse
Chevron 1

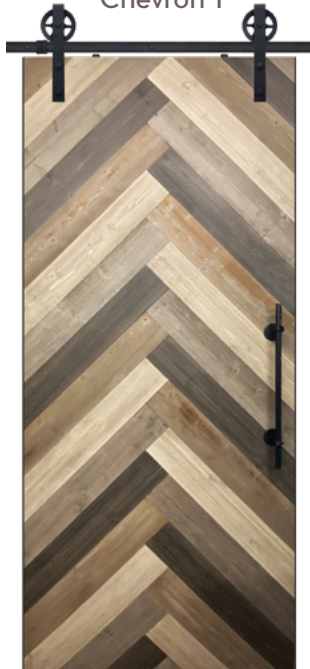

42" wide x 96" tall Rustic Chevron door shown here with Vintage hardware and Gila 24" pull. Plank colors used are Barnwood, Riverwood, Stormy Grey, Weathered Brown.

Rustic Farmhouse
Chevron 2



36" wide x 96" tall Rustic Chevron door shown with Gage stainless steel hardware and Metro 48" pull. Plank colors used are Weathered White, Charcoal Dusk, Cloudy Grey.

Rustic Farmhouse
Chevron 3



36" wide x 96" tall Rustic Chevron door shown with Royal hardware and Concord pull. Plank colors used are Weathered White, Sandy Beach, Riverwood, Barnwood.

Rustic Farmhouse
Chevron 4: Sandy Beach

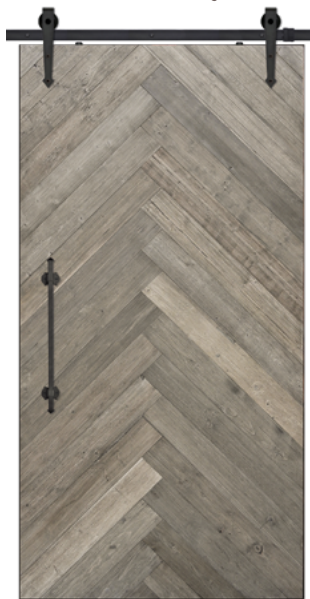

42" wide x 84" tall Rustic Farmhouse Chevron door shown with Sandy Beach planks, Philmont hardware and San Juan 24" pull.

Rustic Farmhouse
Chevron 4: Riverwood

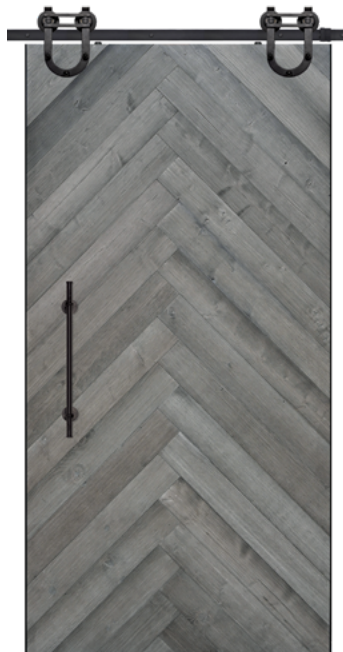

48" wide x 96" tall Rustic Farmhouse Chevron door shown with Riverwood planks, Waggoner hardware and Gila 24" pull.

For this Chevron 4 door you may select from any of the 8 Plank colors listed here (see page 39):

1. Stormy Grey
2. Cloudy Grey
3. Barnwood
4. Sandy Beach
5. Charcoal Dusk
6. Riverwood
7. Weathered Brown
8. Weathered White

All doors above are available in 3 door heights:
80", 84", and 96".
And in 4 widths: 32", 36", 42", and 48".

These doors may use
**TRADITIONAL or HOUDINI
HARDWARE**



THE RUSTIC FARMHOUSE BARNCRAFT® COLLECTION

Rustic Farmhouse
Horizontal 1

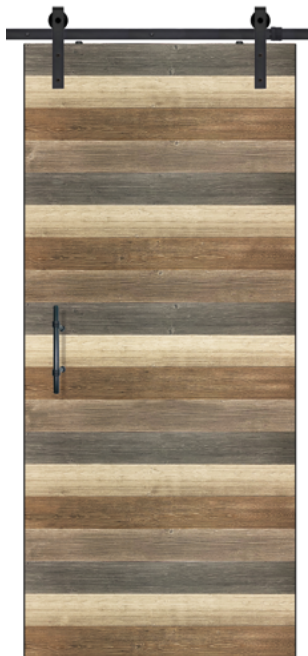

42" wide x 96" tall Rustic Farmhouse Horizontal door shown with Slade hardware and Sierra pull. Plank colors used are Barnwood, Riverwood, Stormy Grey, Weathered Brown.

Rustic Farmhouse
Horizontal 2



36" wide x 96" tall Rustic Farmhouse Horizontal door shown with Vintage hardware and Gila 24" pull. Plank colors used are Weathered White, Charcoal Dusk, Cloudy Grey.

Rustic Farmhouse
Horizontal 3



36" wide x 96" tall Rustic Farmhouse Horizontal door shown with Gage hardware and Del Mar pull. Plank colors used are Weathered White, Sandy Beach, Riverwood, Barnwood.

Rustic Farmhouse
Horizontal 4: Stormy Grey



42" wide x 96" tall Rustic Farmhouse Horizontal door shown with Stormy Grey color planks, stainless steel Slade hardware and Metro 60" pull.

Rustic Farmhouse
Horizontal 4: Barnwood



36" wide x 96" tall Rustic Farmhouse Horizontal door shown with Barnwood color planks, black Slade hardware and Vista inset pull.

Most Planks on these doors are 5" wide. The 80" tall door has 16 planks. The 84" tall door has 17 planks (the bottom plank is 4" wide). The 96" tall door has 19 planks (the bottom plank is 6" wide).

For this Horizontal 4 door you may select from any of the 8 Plank colors (see page 39):

1. Stormy Grey
2. Cloudy Grey
3. Barnwood
4. Sandy Beach
5. Charcoal Dusk
6. Riverwood
7. Weathered Brown
8. Weathered White

All doors above are available in 3 door heights:
80", 84", and 96".
And in 4 widths: 32", 36", 42", and 48".

These doors may use
TRADITIONAL or **HOUDINI**
HARDWARE





36" x 96" Contemporary Metal 9 Lite 1 Panel sliding door with Clear glass and the concealed Houdini Hardware.

METAL & GLASS

The Contemporary Metal Collection features flush glazed doors with very narrow aluminum stiles and rails, creating a modern minimalist look. All doors are 1-1/8" thick, coated with a permanent black finish, and utilize heavy 3/8" thick tempered safety glass. Doors include 1 door pull which may be mounted on right or left side of door. Other door pulls will not fit this door.

All 7 Contemporary Metal door designs are available in two heights (84" and 96"), and two widths (36" and 42"). The 4 Lite, 8 Lite and 12 Lite doors are also available in a 48" width. The stiles and rails are 1-5/8" wide, and coated with a permanent black finish (other finish options not available). Tempered safety glass is available in Clear or Cloud glass. Hardware options are Gage traditional hardware or Houdini Hardware (which requires use of the Houdini Adapter #BDHHA). Gage hardware is available in black or stainless steel finishes. See pages 6-10 for additional sliding hardware information.

Glass Texture Options



Clear - 1 PRIVACY RATING



Cloud - 6 PRIVACY RATING

Gage Roller Options



Black



Stainless Steel

These doors use **GAGE TRADITIONAL HARDWARE** or **HOUDINI HARDWARE** with adapter kit (see page 8).

CONTEMPORARY METAL COLLECTION

BARNCRAFT® PREMIUM SLIDING DOORS

THE CONTEMPORARY METAL BARNCRAFT® COLLECTION



3 Lite/ 1 Panel
Contemporary Metal



36" wide x 96" tall 3 Lite / 1 Panel shown above with black Gage hardware and Cloud glass. Door pull included.

6 Lite/ 1 Panel
Contemporary Metal



36" wide x 96" tall 6 Lite / 1 Panel shown above with black Gage hardware and Clear glass. Door pull included.

9 Lite/ 1 Panel
Contemporary Metal



36" wide x 96" tall 9 Lite / 1 Panel shown above with black Gage hardware and Clear glass. Door pull included.

1 Lite
Contemporary Metal



36" wide x 96" tall 1 Lite shown above with black Gage hardware and Cloud glass. Door pull included.

4 Lite
Contemporary Metal



48" wide x 96" tall 4 Lite shown above with black Gage hardware and Cloud glass. Door pull included. Also available in 36" and 42" widths.

8 Lite
Contemporary Metal



36" wide x 96" tall 8 Lite shown above with black Gage hardware and Cloud glass. Door pull included.

12 Lite
Contemporary Metal



36" wide x 96" tall 12 Lite shown above with black Gage hardware and Cloud glass. Door pull included.

All doors above are available in 2 heights: 84" or 96",
2 widths: 36" or 42", with 2 glass types: Clear or Cloud.
The 4, 8 and 12 Lite doors also available in 48" wide.

These doors use GAGE TRADITIONAL
HARDWARE or HOUDINI HARDWARE
with adapter kit (see page 8).





48" x 96" Westwood sliding door, shown here with Timber Wolf Traditional finish, stainless steel Slade sliding hardware and Vista inset pull handle.

MODERN BIRCH DOORS up to 9'0" Tall!

The Contemporary Birch Collection features six minimalist designs in premium Birch wood. The collection offers a choice of multiple stain and paint options that bring out an understated elegance.

Complement these birch contemporary sliding doors with either black or stainless steel hardware, or choose Houdini concealed hardware.

These doors are all 1-3/4" thick, with the birch wood and pattern detail on both sides of the door. Glass option photos shown on page 45.

Minimalist Modern Design

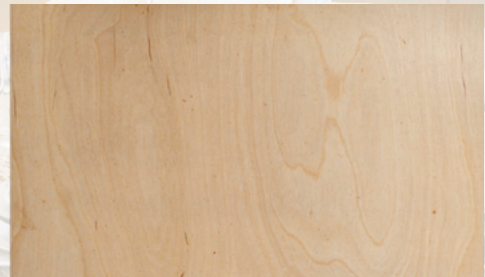

Birch wood is a creamy white sap wood with some golden brown flame patterns, presenting a warm and pleasing appearance. It has a fine, uniform texture with closed pores. Birch wood is a strong and very stable wood with beautiful grain patterns that highlight any stain color. Birch wood also provides an excellent surface for paint finishes.

These doors may use
**TRADITIONAL or HOUDINI
HARDWARE**

CONTEMPORARY BIRCH COLLECTION

BARNCRAFT® PREMIUM SLIDING DOORS

THE CONTEMPORARY BIRCH BARNCRAFT® COLLECTION

Birch Stain Finish Options

Twenty-seven factory finish color options and nine Palette Collection paint colors are available for all of the Birch Collection doors. These doors are available unfinished **or** factory finished in the 27 colors as shown on pages 19-21, or the 9 paint colors shown on page 35. The Traditional colors on Birch wood include the stain color and a clear urethane satin-sheen top coat. The Antique colors are darker, and suggest an aged appearance. The Distressed colors are the same as the Antique, with the addition of faux worm holes and cracks for a more rustic aged look. The Palette Collection paint colors are a protective monochromatic coating with outstanding adhesive properties and no need for a primer coat.

The doors are available with the routed design or mirror available on 1 side or both sides of the door. A "flush" door with no glass or pattern is also available.

The mirror option is available in 2 widths (36" or 42"), and in 3 heights (80", 84", and 96"), and includes a 28" wide safety glass mirror that is 68" high on a 80" or 84" tall door, and 80" high on a 96" tall door.

All BarnCraft sliding door hardware may be used on these doors. See pages 6-10 for all available BarnCraft sliding hardware options.

Glass Texture Options for Contemporary Birch Wood Doors

The Santa Monica doors shown on page 47 offer these 6 glass options.



1 - PRIVACY RATING

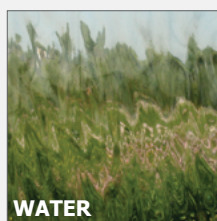

3 - PRIVACY RATING

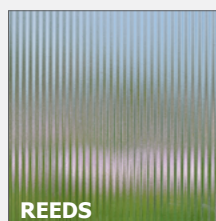

7 - PRIVACY RATING



9 - PRIVACY RATING

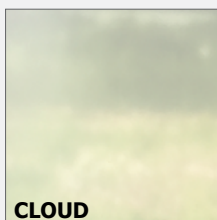

9 - PRIVACY RATING



10 - PRIVACY RATING

Birch Door Size Options

Birch Contemporary doors are available in the following sizes:

80" tall x 30" wide
80" tall x 36" wide
80" tall x 42" wide
80" tall x 48" wide

84" tall x 30" wide
84" tall x 36" wide
84" tall x 42" wide
84" tall x 48" wide

96" tall x 30" wide
96" tall x 36" wide
96" tall x 42" wide
96" tall x 48" wide

108" tall x 30" wide*
108" tall x 36" wide*
108" tall x 42" wide*
108" tall x 48" wide*

* 108" tall N/A on mirrored doors

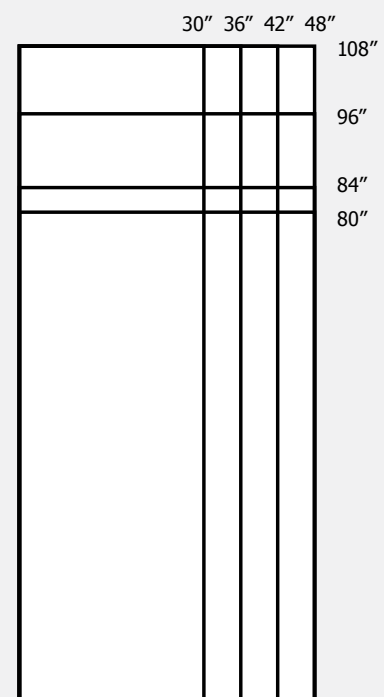

THE CONTEMPORARY BIRCH BARNCRAFT® COLLECTION

Brentwood
Contemporary Birch



42" x 96" Birch Brentwood door, shown with Natural Traditional finish, stainless steel Gage hardware and 48" Metro pull. Also available in 80", 84" and 108" tall.

Westwood
Contemporary Birch



42" x 96" Birch Westwood door, shown with Winter Antique finish, Waggoner hardware and Gila 24" pull handle. Also available in 80", 84" and 108" tall.

Fleetwood
Contemporary Birch



36" x 96" Birch Fleetwood door, shown with Winter Traditional finish, Vintage hardware and Gila 24" pull. Also available in 80", 84", 108" tall.

Inglewood
Contemporary Birch



36" x 96" Birch Inglewood door, with Forest Grey Traditional finish, Royal hardware and Sierra pull. Also available in 80", 84", 108" tall.

Flush
Contemporary Birch



42" x 96" Birch Flush door, shown with Winter finish, and stainless steel Gage hardware and Metro 48" pull handle. Also available in 80", 84" and 108" tall, and 30", 36" and 48" wide.

Chevron
Contemporary Birch



42" x 108" Birch Chevron door, shown with Natural finish, Waggoner hardware, and Gila 24" pull handle. Also available in 80", 84", 96" tall, and 30", 36" and 48" wide.

2 Panel Chevron
Contemporary Birch



42" x 96" Birch 2 Panel Chevron door, shown with Natural finish, and stainless steel Gage hardware and Vista pull. Also available in 80", 84" and 108" tall, and 30", 36" and 48" wide.

For all Contemporary Birch doors, choose from 27 finish options on pages 19-21, OR from the 9 paint color options on page 37:

1. Arcade White
2. Shoji White
3. Softened Green
4. Grey Clouds
5. Gale Force
6. Rookwood
Terra Cotta
7. Urbane Bronze
8. Perle Noir
9. Tricorn Black

Doors above are available in 4 heights: 80", 84", 96", and 108".
And 4 widths: 30", 36", 42", and 48".

These doors may use
**TRADITIONAL or HOUDINI
HARDWARE**



THE CONTEMPORARY BIRCH BARNCRAFT® COLLECTION

Mirror Full-Lite
Contemporary Birch



36" x 84" Birch Mirror door, shown with Wagoner hardware, Winter Antique finish, and 24" Gila pull. Mirror size is 28" x 68".

Mirror Full Lite
Contemporary Birch



42" wide x 96" tall Birch Mirror door shown with Natural Traditional finish, stainless steel Gage hardware, and 48" Metro pull. Mirror size is 28" x 84".

Mirror Full Lite
Contemporary Birch

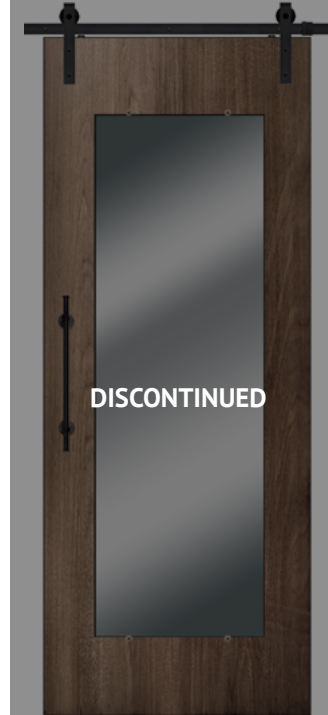

42" wide x 108" tall Birch Mirror door shown with Natural Distressed finish, black Slade hardware, and 24" Gila pull. Mirror size is 28" x 84".

4-Lite Santa Monica
Contemporary Birch



36" wide x 96" tall Birch Santa Monica with Water glass. Glass options: Clear, Water, Rain, Cloud, Reeds and Mirror. The 96" and 108" tall Santa Monica doors have 4 glass lites. Shown with Canyon Brown Distressed finish, stainless steel Slade hardware and 60" Metro handle.

3-Lite Santa Monica
Contemporary Birch



36" wide x 84" tall Birch Santa Monica door with 3 glass lites. Glass options: Water, Rain, Cloud, Clear, Reeds, Mirror. 80" and 84" tall Santa Monica doors have 3 glass lites. Shown with Canyon Brown Antique finish, Mirror glass, black Gage hardware, and Santa Fe pull. This door shown on page 5 and at right.



84" tall Santa Monica bypass double doors with mirror glass option, matching header, Sierra Brown Distressed finish, Gage hardware and Corona pull handles.

Visible glass size on the Santa Monica 3-lite and 4-lite is 22" x 14".

Mirrored doors in 3 heights: 80", 84", 96". The 4-Lite also in 108".

These doors may use
**TRADITIONAL or HOUDINI
HARDWARE**





36" x 80" Beverly 5 Lite Mahogany sliding door with Cinnamon Traditional finish, Cloud glass, Royal hardware, and Corona pull handle.

ELEGANT MAHOGANY

The Glass & Mahogany Door Series in the BarnCraft Collection is available in Mahogany wood with choice of Traditional, Distressed or Antique finish – or unfinished. Mahogany is a fine straight-grained wood that ranges from rich golden to deep brown color and has a beautiful sheen when finished. See pages 19-21 for available finish colors.

All BarnCraft sliding door hardware may be used on these Mahogany doors. Please see pages 6-10 for all available BarnCraft sliding hardware options.

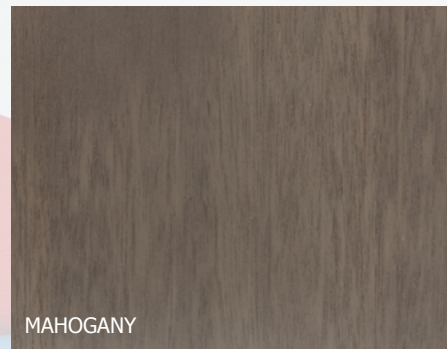

These doors may use
**TRADITIONAL or HOUDINI
HARDWARE**

MAHOGANY & GLASS DOOR COLLECTION

BARNCRAFT® PREMIUM SLIDING DOORS

THE MAHOGANY & GLASS BARNCRAFT® COLLECTION

Timeless Design

The Mahogany Door Series of BarnCraft sliding doors include these Mahogany doors with glass, in 2 door size options and up to 4 glass texture options. Choose from raw unfinished wood or from 27 stain colors with Traditional, Distressed or Antique finish options (refer to pages 19-21 for all finish options). Mahogany varies from rich golden to deep brown colors and has a straight to wavy, even graining that has a beautiful sheen when finished.

See pages 6- 10 for BarnCraft sliding door hardware options. Choose from either the new concealed Houdini Hardware or the Traditional black or stainless steel options to complement the various sliding doors in this Glass & Mahogany Door Series.

Glass texture options are shown below.

These doors are 1-3/4" thick. The Continental Series and Beverly doors on page 50 are True Divided Lite doors, and the doors on page 51 are SDL, or Simulated Divided Lite doors.



36" x 80" Continental 3 Lite sliding door with Canyon Antique finish, Large Flemish glass, black Slade hardware, and Monterey pull handle.

Glass Texture Options for Mahogany Doors

All glass used in these sliding barn doors is single-thickness, tempered safety glass. All of the Continental doors on page 50 and all the SDL doors on page 51 may be ordered with Clear, Flemish, and Rain glass textures.

The Beverly TDL doors on page 50 are available with Clear, Rain, Water, Reeds, Cloud and Mirror glass.

The SDL doors on page 51 are available with Clear, Flemish, Rain, and Water glass textures.



CLEAR

1 - PRIVACY RATING

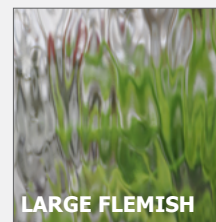

LARGE FLEMISH

5 - PRIVACY RATING

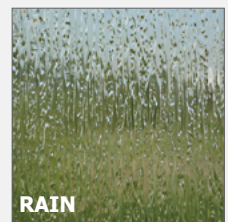

RAIN

9 - PRIVACY RATING

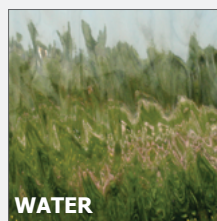

WATER

3 - PRIVACY RATING

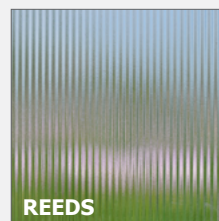

REEDS

7 - PRIVACY RATING

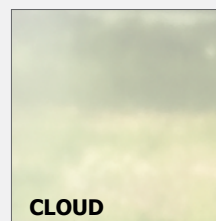

CLOUD

9 - PRIVACY RATING

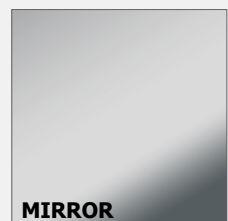

MIRROR

10 - PRIVACY RATING

THE MAHOGANY & GLASS BARNCRAFT® COLLECTION

4 Lite
Continental TDL



36" wide x 80" tall Continental 4 Lite DoorCraft Mahogany door, shown with Clear glass, Charcoal finish, stainless steel Slade hardware and Metro 16" pull. Clear, Flemish, and Rain glass textures available. (Also in 32" wide.)

3 Lite
Continental TDL



36" wide x 80" tall Continental 3 Lite DoorCraft Mahogany door, shown with Winter Antique finish, Flemish glass, Gage hardware and Metro 12" pull. Clear, Flemish, and Rain glass available. (Also in 32" wide.)

5 Lite
Beverly TDL



36" wide x 80" tall Beverly TDL 5 Lite DoorCraft Mahogany, shown with Owl Grey Antique finish, Cloud glass, black Gage hardware and Metro 12" pull. Glass options are: Clear, Rain, Reeds, Water, Cloud, and Mirror.

5 Lite
Continental TDL



36" wide x 96" tall Continental TDL 5 Lite DoorCraft Mahogany, shown with Forest Grey finish, Clear glass, and stainless steel Gage hardware and Metro 48" pull. Clear, Flemish, and Rain glass textures are available.

4 Lite
Continental TDL



36" wide x 96" tall Continental TDL 4 Lite DoorCraft Mahogany, shown with Canyon Brown finish, Rain glass, Royal hardware and Gila 24" pull handle. (Also in 30", 32" widths). Clear, Flemish, and Rain glass textures are available.

6 Lite
Beverly TDL



36" wide x 96" tall Beverly TDL 6 Lite DoorCraft Mahogany, shown with Winter Antique finish, Mirror glass, stainless steel Slade hardware and Metro 12" pull. Also available in 42" width. Glass options: Clear, Rain, Reeds, Water, Cloud, Mirror.

See page 49 for glass options available for these TDL doors.

These doors may use
**TRADITIONAL or HOUDINI
HARDWARE**



THE MAHOGANY & GLASS BARNCRAFT® COLLECTION

6 Lite SDL



36" wide x 80" tall Mahogany 6 Lite SDL door, shown here with Forest Grey Traditional finish, Large Flemish glass, Vintage hardware and Gila pull handle. (Also in 32" width). Clear, Water, Rain and Flemish glass textures available.

4 Lite SDL



36" wide x 80" tall Mahogany 4 Lite SDL door, shown here with Owl Grey Traditional finish, Rain glass, Philmont hardware and San Juan 24" pull handle. (Also in 32" width). Clear, Flemish, Water and Rain glass textures are available.

6 Lite SDL



36" wide x 96" tall 6 Lite SDL DoorCraft Mahogany, shown with Forest Grey finish, Clear glass, stainless steel Slade hardware, Metro 12" pull. (Also in 32" width). Clear, Flemish, Water and Rain glass textures are available.

4 Lite SDL



36" wide x 96" tall 4 Lite SDL DoorCraft Mahogany, shown with Winter Antique finish, Water glass, Vintage hardware, Gila 24" pull. (Also in 32" width). Clear, Flemish, Water and Rain glass textures are available.



See page 49 for glass options available for these SDL doors.

NOTE: The images throughout this catalog showing prefinish options offer an indication of final appearance, but due to variations in the texture, grain and color of the wood, the actual appearance will vary.

These doors may use
**TRADITIONAL or HOUDINI
HARDWARE**



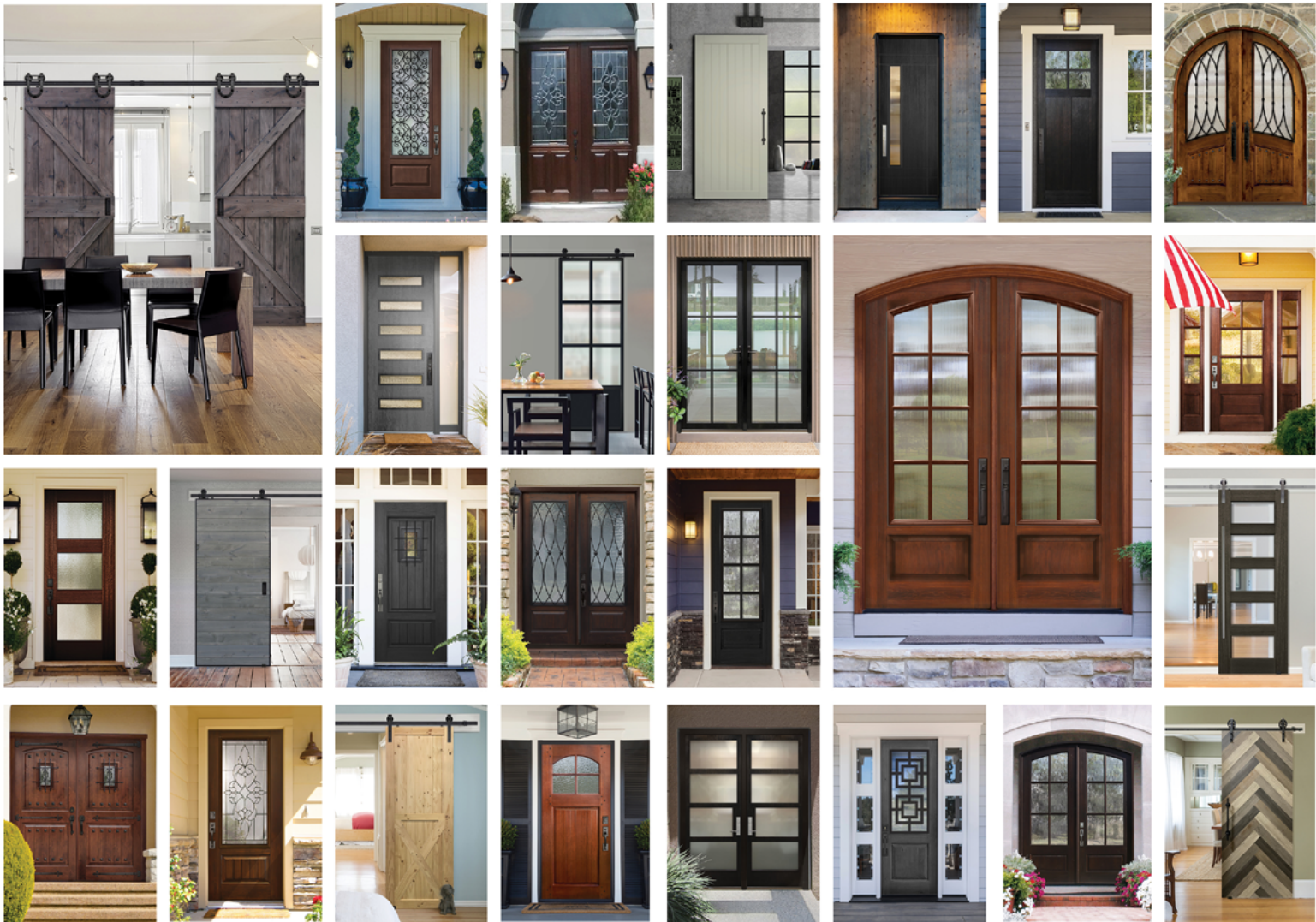

GLASSCRAFT[®] DOOR COMPANY

2002 Brittmoore Road | Houston, Texas 77043 | 713-690-8282



The BarnCraft[®] Collection

Premium Sliding Barn Doors

GlassCraft[®] product literature available online at www.glasscraft.com